

Security Command[®]
EXECUTIVE SERIES



User's Guide

Security Command[®]
EXECUTIVE SERIES



User's Guide

Silencing an Alarm

All/Perimeter and Home/Away Systems

1. While the alarm bell or siren is sounding, enter your user code. The keypad displays **DISARM SILENCE**.
2. Press the SELECT key under **SILENCE** to stop the bell or siren. This does NOT disarm the system.
3. If your system is programmed to send an Abort (alarm cancel) report to the central station, the keypad displays **ALARM CANCELLED**.

Area Systems

1. While the alarm bell or siren is sounding, enter your user code. The system silences the alarm bell or siren.
2. If your system is programmed to send an Abort (alarm cancel) report to the central station, the keypad displays **ALARM CANCELLED**.

Copyright © 1996, 1997 Digital Monitoring Products, Inc.
Information furnished by DMP is believed to be accurate and reliable.
This information is subject to change without notice.

The XR20 panel is UL listed for Grade A Household Service as well as Commercial Burglary Service.

Silencing an Alarm

All/Perimeter and Home/Away Systems

1. While the alarm bell or siren is sounding, enter your user code. The keypad displays **DISARM SILENCE**.
2. Press the SELECT key under **SILENCE** to stop the bell or siren. This does NOT disarm the system.
3. If your system is programmed to send an Abort (alarm cancel) report to the central station, the keypad displays **ALARM CANCELLED**.

Area Systems

1. While the alarm bell or siren is sounding, enter your user code. The system silences the alarm bell or siren.
2. If your system is programmed to send an Abort (alarm cancel) report to the central station, the keypad displays **ALARM CANCELLED**.

Copyright © 1996, 1997 Digital Monitoring Products, Inc.
Information furnished by DMP is believed to be accurate and reliable.
This information is subject to change without notice.

The XR20 panel is UL listed for Grade A Household Service as well as Commercial Burglary Service.

Security Command User's Guide

for XR20 Command Processor Panels

Table of Contents

About your system		
Emergency Evacuation Plans	ii	
About Your Security System	1	
The Security Command Keypad	2	
Special Security Command Messages	3	
Special Security Command Tones	3	
Understanding Security System Terms	4	
How your System Operates	6	
Arming and disarming		
Area System Arming	7	
Area System Disarming	8	
All/Perimeter System Arming	9	
All/Perimeter System Disarming	10	
Home/Away System Arming	11	
Home/Away System Disarming	12	
User Menu Functions		
Security Command User Menu	13	
User Checkin	13	
Sensor Reset		13
Outputs On Off		14
Bypass Zones		14
Zone Monitor		15
System Test		16
User Codes		16
Ambush Codes		18
Schedules		19
Date and Time		20
Display Events		21
How Your System is Setup		
System Setup		24
User Codes Record Sheet		25
Optional Features		
Easy Entry™ User's Guide		27
Pager Direct™ User's Guide		29
Phone Access™ User's Guide		31
FA113 Wireless Remote User's Guide		33
Index		34

i

Security Command User's Guide

for XR20 Command Processor Panels

Table of Contents

About your system		
Emergency Evacuation Plans	ii	
About Your Security System	1	
The Security Command Keypad	2	
Special Security Command Messages	3	
Special Security Command Tones	3	
Understanding Security System Terms	4	
How your System Operates	6	
Arming and disarming		
Area System Arming	7	
Area System Disarming	8	
All/Perimeter System Arming	9	
All/Perimeter System Disarming	10	
Home/Away System Arming	11	
Home/Away System Disarming	12	
User Menu Functions		
Security Command User Menu	13	
User Checkin	13	
Sensor Reset		13
Outputs On Off		14
Bypass Zones		14
Zone Monitor		15
System Test		16
User Codes		16
Ambush Codes		18
Schedules		19
Date and Time		20
Display Events		21
How Your System is Setup		
System Setup		24
User Codes Record Sheet		25
Optional Features		
Easy Entry™ User's Guide		27
Pager Direct™ User's Guide		29
Phone Access™ User's Guide		31
FA113 Wireless Remote User's Guide		33
Index		34

i

Emergency Evacuation Plans

The National Fire Protection Association recommends that you establish an emergency evacuation plan to safeguard lives in the event of a fire or other emergency. Use the following steps as a guide.

Draw a floorplan of your home or business

On a clean sheet of paper, draw the walls, windows, doors, and stairs. Also draw any obstacles that a person may encounter while exiting the building such as large furniture or appliances.

Develop escape routes

Determine at least two routes the occupants in each room can take to safely escape. One route can be the most obvious such as the door. Another can be through a window that can be easily opened. If the window is high off the ground, an escape ladder should be provided.

Draw arrows on the floorplan to show escape routes from each room.

Decide where to meet

Prearrange a meeting place outside and away from where emergency personnel are likely to be working. A neighbor's house or across the street in the front of the house are good locations. Always perform a head count to make sure all occupants safely exited. **NEVER ENTER A BURNING BUILDING.** If the head count shows one or more persons missing, give this information immediately to the authorities. Never enter a building to look for someone.

Practice your escape plans

Devising an escape plan is only the beginning, before the plan can be effective everyone should practice the escape routes from each room.

ii

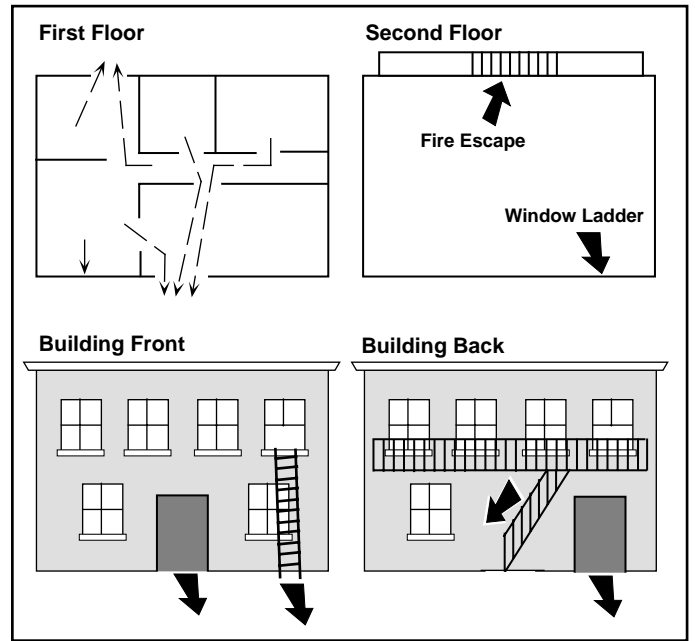

Early detection

The best way to survive a fire or other emergency is to get out early. The installation of a fire alarm system, with smoke and carbon monoxide detectors in each room, can greatly decrease your risk of loss or injury.

Emergency Evacuation Plans

The National Fire Protection Association recommends that you establish an emergency evacuation plan to safeguard lives in the event of a fire or other emergency. Use the following steps as a guide.

Draw a floorplan of your home or business

On a clean sheet of paper, draw the walls, windows, doors, and stairs. Also draw any obstacles that a person may encounter while exiting the building such as large furniture or appliances.

Develop escape routes

Determine at least two routes the occupants in each room can take to safely escape. One route can be the most obvious such as the door. Another can be through a window that can be easily opened. If the window is high off the ground, an escape ladder should be provided.

Draw arrows on the floorplan to show escape routes from each room.

Decide where to meet

Prearrange a meeting place outside and away from where emergency personnel are likely to be working. A neighbor's house or across the street in the front of the house are good locations. Always perform a head count to make sure all occupants safely exited. **NEVER ENTER A BURNING BUILDING.** If the head count shows one or more persons missing, give this information immediately to the authorities. Never enter a building to look for someone.

Practice your escape plans

Devising an escape plan is only the beginning, before the plan can be effective everyone should practice the escape routes from each room.

ii

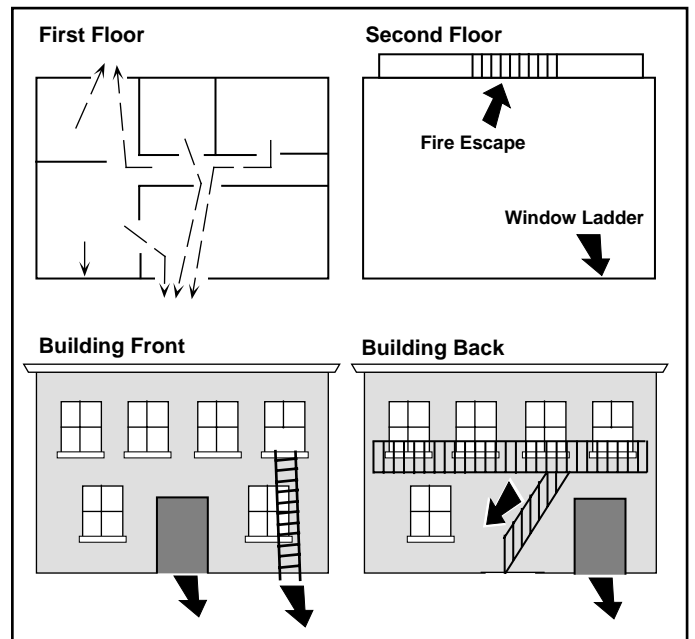

Early detection

The best way to survive a fire or other emergency is to get out early. The installation of a fire alarm system, with smoke and carbon monoxide detectors in each room, can greatly decrease your risk of loss or injury.

Introduction

About Your Security System

Your Security Command system has been designed with your safety and comfort in mind. It uses the latest in computer technology to create the most user friendly security and fire system on the market today.

The system combines ease of use with a simple to understand Security Command keypad display to offer the full range of features requested by today's security system owners. Security Command can protect both the interior and perimeter of your home or business while you're away or just the perimeter when you're inside giving you a wall of security and peace of mind.

You can turn portions of your protection on or off at any time by pressing a few buttons. You can add, delete, and change personal security codes at any time or check the status of all protection devices in the system.

Parts of the System

There are two main parts to the Security Command system, the Security Command keypad and the keypad User Menu.

Security Command keypad

This is the device we've placed at certain locations throughout the premises that allow you to turn the system's protection on and off using your personal security code number.

Keypad User Menu

The keypad also supplies a User Menu containing all of the functions you need to fully operate your system. For example, to change a personal security code number.

A Note About False Alarms

One of the most important concerns facing the security industry today is false alarms. The accidental dispatching of police and fire agencies places others in jeopardy by limiting the response capability of those emergency service units.

As part of our commitment to reducing false alarms, we'd like to encourage you to read this guide thoroughly. All the information contained here can help you quickly, and comfortably, learn the operation of the Security Command system. If you have any additional questions, or feel that you need more training, please don't hesitate to contact us.

Test Your System Weekly

It is recommended that you test the burglary portion of your system at least once each week. Testing should involve an active test of all doors, windows, and motion detectors connected to your system. If your system also has fire protection, call the service department to find out how this portion of your system should be tested.

Refer to the System Test section of this guide for instructions on testing the burglary portion of your system.

Introduction

About Your Security System

Your Security Command system has been designed with your safety and comfort in mind. It uses the latest in computer technology to create the most user friendly security and fire system on the market today.

The system combines ease of use with a simple to understand Security Command keypad display to offer the full range of features requested by today's security system owners. Security Command can protect both the interior and perimeter of your home or business while you're away or just the perimeter when you're inside giving you a wall of security and peace of mind.

You can turn portions of your protection on or off at any time by pressing a few buttons. You can add, delete, and change personal security codes at any time or check the status of all protection devices in the system.

Parts of the System

There are two main parts to the Security Command system, the Security Command keypad and the keypad User Menu.

Security Command keypad

This is the device we've placed at certain locations throughout the premises that allow you to turn the system's protection on and off using your personal security code number.

Keypad User Menu

The keypad also supplies a User Menu containing all of the functions you need to fully operate your system. For example, to change a personal security code number.

A Note About False Alarms

One of the most important concerns facing the security industry today is false alarms. The accidental dispatching of police and fire agencies places others in jeopardy by limiting the response capability of those emergency service units.

As part of our commitment to reducing false alarms, we'd like to encourage you to read this guide thoroughly. All the information contained here can help you quickly, and comfortably, learn the operation of the Security Command system. If you have any additional questions, or feel that you need more training, please don't hesitate to contact us.

Test Your System Weekly

It is recommended that you test the burglary portion of your system at least once each week. Testing should involve an active test of all doors, windows, and motion detectors connected to your system. If your system also has fire protection, call the service department to find out how this portion of your system should be tested.

Refer to the System Test section of this guide for instructions on testing the burglary portion of your system.

The Security Command Keypad

Your system may have one or more easy to use Security Command keypads (16 or 32 character) that allow you to properly operate the system. The illustration and descriptions below highlight some of the keypad features:

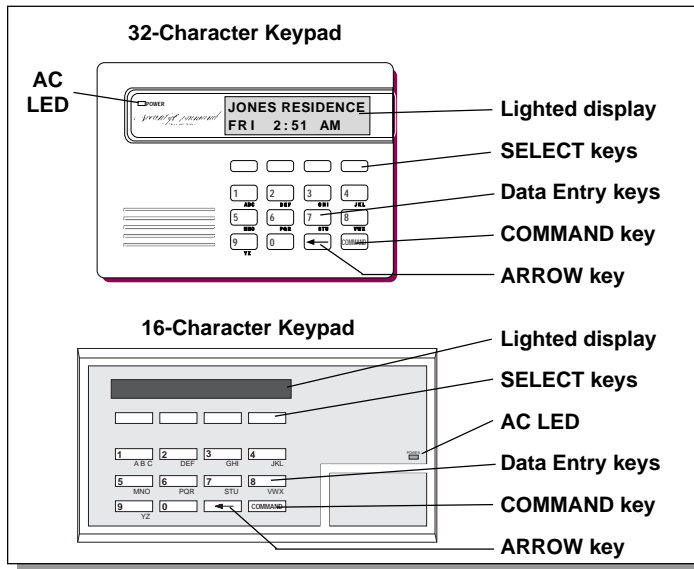

The SELECT keys

There are four keys under the display called the SELECT keys. These keys are one of the features that make your system so easy to operate. They allow you to choose what to do by pressing the SELECT key under choices being shown in the display.

Data Entry keys

These keys allow you to enter your user code when arming or disarming or enter other information into the system.

The ARROW key

The ARROW key is used to go back through the keypad displays while operating your system. You can press the ARROW key to back up through the list of functions in the User Menu or to make a correction by erasing the last character you entered.

The COMMAND key

The COMMAND key allows you to advance through the keypad displays or User Menu or complete a data entry function.

AC LED

This LED remains on steady as long as your system is connected to its AC power supply. Should there be an interruption, the LED turns off and the system's backup battery maintains normal operation for a time allowing you to contact our service department.

32-Character Keypad User Options Menu

Press and hold the ARROW and COMMAND keys for about two seconds. The keypad display shows **SET BRIGHTNESS**. Use the left SELECT key to lower the display brightness. Use the right SELECT key to increase the display brightness. Press COMMAND.

At **SET TONE**, use the left SELECT key to lower the keypad tone. Use the right SELECT key to raise the keypad tone. Press COMMAND.

At **SET VOLUME LEVEL**, use the left SELECT key to lower the keypad volume. Use the right SELECT key to raise the keypad volume. Press the ARROW key to exit out of the User Options menu.

2 Introduction

The Security Command Keypad

Your system may have one or more easy to use Security Command keypads (16 or 32 character) that allow you to properly operate the system. The illustration and descriptions below highlight some of the keypad features:

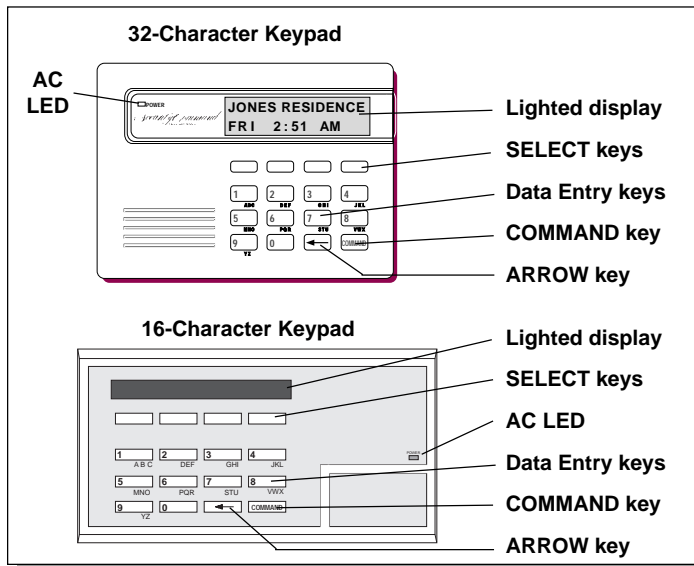

The SELECT keys

There are four keys under the display called the SELECT keys. These keys are one of the features that make your system so easy to operate. They allow you to choose what to do by pressing the SELECT key under choices being shown in the display.

Data Entry keys

These keys allow you to enter your user code when arming or disarming or enter other information into the system.

The ARROW key

The ARROW key is used to go back through the keypad displays while operating your system. You can press the ARROW key to back up through the list of functions in the User Menu or to make a correction by erasing the last character you entered.

The COMMAND key

The COMMAND key allows you to advance through the keypad displays or User Menu or complete a data entry function.

AC LED

This LED remains on steady as long as your system is connected to its AC power supply. Should there be an interruption, the LED turns off and the system's backup battery maintains normal operation for a time allowing you to contact our service department.

32-Character Keypad User Options Menu

Press and hold the ARROW and COMMAND keys for about two seconds. The keypad display shows **SET BRIGHTNESS**. Use the left SELECT key to lower the display brightness. Use the right SELECT key to increase the display brightness. Press COMMAND.

At **SET TONE**, use the left SELECT key to lower the keypad tone. Use the right SELECT key to raise the keypad tone. Press COMMAND.

At **SET VOLUME LEVEL**, use the left SELECT key to lower the keypad volume. Use the right SELECT key to raise the keypad volume. Press the ARROW key to exit out of the User Options menu.

2 Introduction

Special Security Command Messages

As you use your system, you'll occasionally see a keypad display that asks you to enter a user code or that describes a condition on the system. Below are some examples of the displays you'll see:

ALARM

A 24 hour zone (for example, fire or panic) or an armed burglary zone has been faulted. Your system may sound bells or sirens.

ALARM CANCELLED

An authorized user has cancelled an alarm condition by entering their user code.

TROUBLE

There is a problem with a protection device or system component. This display is accompanied by a description of the problem.

ENTER CODE

The system requires you to enter a personal user code. User codes can be required for turning your system on (arming), turning your system off (disarming), and many other system options.

As you enter your user code, the keypad display shows an asterisk (*) in place of each digit pressed. This keeps others from seeing your user code on the display as it's entered.

TRY AGAIN

The user code entered is not recognized by the system. Check the user code and try again.

INVALID CODE

The user code you've entered is considered invalid by the system.

Special Security Command Messages

As you use your system, you'll occasionally see a keypad display that asks you to enter a user code or that describes a condition on the system. Below are some examples of the displays you'll see:

ALARM

A 24 hour zone (for example, fire or panic) or an armed burglary zone has been faulted. Your system may sound bells or sirens.

ALARM CANCELLED

An authorized user has cancelled an alarm condition by entering their user code.

TROUBLE

There is a problem with a protection device or system component. This display is accompanied by a description of the problem.

ENTER CODE

The system requires you to enter a personal user code. User codes can be required for turning your system on (arming), turning your system off (disarming), and many other system options.

As you enter your user code, the keypad display shows an asterisk (*) in place of each digit pressed. This keeps others from seeing your user code on the display as it's entered.

TRY AGAIN

The user code entered is not recognized by the system. Check the user code and try again.

INVALID CODE

The user code you've entered is considered invalid by the system.

SYSTEM TROUBLE or SERVICE REQUIRED

There is an electronic failure in your system. Contact the service department as soon as possible.

Special Security Command Tones

Your keypad also contains a small speaker that allows it to alert you to events as they occur on your system. Below are brief descriptions of the different tones you'll hear from the keypad:

Fire alert: Your keypad may sound a fire tone to alert persons in the vicinity to the alarm condition. This is in addition to the bell output from the alarm panel.

Burglary alert: Your keypad may sound a burglary tone to alert persons in the vicinity to the alarm condition. This is in addition to the bell output from the alarm panel.

Key press tone: A short beep as you press a key on the keypad.

Prewarn tone: A continuous pulsed tone that sounds when you open an entry delay door on a system that is armed (turned on) reminding you to disarm the burglary protection.

Monitor tone: A pulsed tone for one second, one pulse only that sounds whenever a door or window is opened while you're using the zone monitor function from the User Menu. See Zone Monitor.

Trouble tone: A steady tone indicating a trouble condition on your system. Press a SELECT key to silence the trouble tone.

Introduction **3**

SYSTEM TROUBLE or SERVICE REQUIRED

There is an electronic failure in your system. Contact the service department as soon as possible.

Special Security Command Tones

Your keypad also contains a small speaker that allows it to alert you to events as they occur on your system. Below are brief descriptions of the different tones you'll hear from the keypad:

Fire alert: Your keypad may sound a fire tone to alert persons in the vicinity to the alarm condition. This is in addition to the bell output from the alarm panel.

Burglary alert: Your keypad may sound a burglary tone to alert persons in the vicinity to the alarm condition. This is in addition to the bell output from the alarm panel.

Key press tone: A short beep as you press a key on the keypad.

Prewarn tone: A continuous pulsed tone that sounds when you open an entry delay door on a system that is armed (turned on) reminding you to disarm the burglary protection.

Monitor tone: A pulsed tone for one second, one pulse only that sounds whenever a door or window is opened while you're using the zone monitor function from the User Menu. See Zone Monitor.

Trouble tone: A steady tone indicating a trouble condition on your system. Press a SELECT key to silence the trouble tone.

Introduction **3**

Understanding Security System Terms

Throughout this guide, and in some displays on your keypad, you'll see certain words or phrases that might be unfamiliar. Although every effort has been made to use terms that are commonly known, there are some for which there was no acceptable substitute.

Below are some terms you'll see here and on your keypad display:

Arming

This is the term used for turning on the burglary protection in one or more areas of the system. Your system may require you to enter a user code. When armed, the system is able to sound alarm bells or sirens and, if monitored, send alarm reports to a central station when a burglary zone is faulted.

Fire, panic, and other 24 hour devices are always turned on and do not need to be armed.

Disarming

This means turning off one or more areas of the system. When disarmed, the system does NOT sound alarms or send alarm reports to a central station when a burglary zone is faulted.

Zone

A zone refers to a group of one or more protected openings or protection devices assigned the same zone number. Each door or window, motion detector, smoke detector, or other device has a zone number and a name.

Often, similar devices in the same general area will share the same zone. For example, the windows on the east side of the premises can all be grouped together in a zone named **E. WINDOWS**.

4 Introduction

Understanding Security System Terms

Throughout this guide, and in some displays on your keypad, you'll see certain words or phrases that might be unfamiliar. Although every effort has been made to use terms that are commonly known, there are some for which there was no acceptable substitute.

Below are some terms you'll see here and on your keypad display:

Arming

This is the term used for turning on the burglary protection in one or more areas of the system. Your system may require you to enter a user code. When armed, the system is able to sound alarm bells or sirens and, if monitored, send alarm reports to a central station when a burglary zone is faulted.

Fire, panic, and other 24 hour devices are always turned on and do not need to be armed.

Disarming

This means turning off one or more areas of the system. When disarmed, the system does NOT sound alarms or send alarm reports to a central station when a burglary zone is faulted.

Zone

A zone refers to a group of one or more protected openings or protection devices assigned the same zone number. Each door or window, motion detector, smoke detector, or other device has a zone number and a name.

Often, similar devices in the same general area will share the same zone. For example, the windows on the east side of the premises can all be grouped together in a zone named **E. WINDOWS**.

4 Introduction

Entry or Exit Zone

Almost all systems have one or more doors through which you can enter or exit the premises. These doors are programmed with a delay time to allow you to enter or exit while the system is armed without setting off the alarm.

When you arm the system, activity on all burglary zones is ignored until the programmed exit delay time expires. Once that time has expired and the system is fully armed, opening the door causes the panel to start the *entry* delay time. During the entry delay time, you must enter a valid user code to disarm the system or an alarm will occur.

Instant Zone

Exterior windows and non entry doors, or interior protection devices, are typically not programmed with delay times. If these zones are faulted while the system is armed, an alarm occurs instantly.

24 Hour Zone

A 24 hour zone is never assigned to an area and is not turned on or off by arming or disarming your system. Some examples of 24 hour zones are: fire zones, panic zones, and temperature control zones.

Areas

An area is made up of burglary zones that can be armed or disarmed together. The Perimeter area, for example, consists of all the doors and windows on the outside of the building. When you arm the Perimeter, these zones sound an alarm if tripped.

Entry or Exit Zone

Almost all systems have one or more doors through which you can enter or exit the premises. These doors are programmed with a delay time to allow you to enter or exit while the system is armed without setting off the alarm.

When you arm the system, activity on all burglary zones is ignored until the programmed exit delay time expires. Once that time has expired and the system is fully armed, opening the door causes the panel to start the *entry* delay time. During the entry delay time, you must enter a valid user code to disarm the system or an alarm will occur.

Instant Zone

Exterior windows and non entry doors, or interior protection devices, are typically not programmed with delay times. If these zones are faulted while the system is armed, an alarm occurs instantly.

24 Hour Zone

A 24 hour zone is never assigned to an area and is not turned on or off by arming or disarming your system. Some examples of 24 hour zones are: fire zones, panic zones, and temperature control zones.

Areas

An area is made up of burglary zones that can be armed or disarmed together. The Perimeter area, for example, consists of all the doors and windows on the outside of the building. When you arm the Perimeter, these zones sound an alarm if tripped.

Understanding Security System Terms

Central Station Monitoring

Your system can also be programmed to automatically send alarm, trouble, and arming and disarming reports to a central station. Operators at the central station can in turn dispatch the appropriate authorities or contact you with the specific event information.

Status

Status is a feature that automatically displays the armed or disarmed status of your system on the Security Command keypads. Alarm or trouble conditions on a zone or a system monitor such as AC or battery trouble can also be displayed. There are two types of status information available: **Armed Status** and **Status List**.

Armed Status

With Armed Status, the keypad displays the current armed condition of areas within your security system.

The keypad displays When

PERIMETER ON The perimeter areas are on

ALL SYSTEM ON All areas are on

PERIM/INT ON The perimeter and interior areas are on but the bedroom area is off

Status List

The keypad Status List displays any alarm or trouble condition on a zone and any trouble condition that occurs with the AC power or battery power. If more than one alarm or trouble condition occurs at the same time, the keypad sequences this information on its display.

If your system contains any Panic zones, these are *not* displayed on the keypad for security reasons.

If an alarm occurs on a non-fire 24 hour zone or a system monitor, it remains in the Status List until it restores. If one or more armed burglary zones trips, the last one to trip remains in the Status List. The burglary zone alarm remains in the Status List for several minutes or until it's cleared by disarming the system.

Exit Error

This is an automatic function of the panel that prevents an alarm from occurring if an exit door doesn't close all the way after the system has been armed. Here's how it works:

You close all doors and windows, arm the system, and then leave by the front door. You close the door but it doesn't latch and opens slightly causing the front door zone to show as an open to the system. After the exit delay time expires the system attempts to arm the front door zone but recognizes the open condition and, instead of sending an alarm report to the central station, sends an Exit Error report and force arms the door. (If the door closes at a later time it will be included back into the system.) The system sounds the alarm sirens for 15 seconds to alert you of the condition and provide an opportunity for you to close the door.

The Exit Error feature allows the central station to acknowledge the arming error without dispatching the police on a false alarm.

Understanding Security System Terms

Central Station Monitoring

Your system can also be programmed to automatically send alarm, trouble, and arming and disarming reports to a central station. Operators at the central station can in turn dispatch the appropriate authorities or contact you with the specific event information.

Status

Status is a feature that automatically displays the armed or disarmed status of your system on the Security Command keypads. Alarm or trouble conditions on a zone or a system monitor such as AC or battery trouble can also be displayed. There are two types of status information available: **Armed Status** and **Status List**.

Armed Status

With Armed Status, the keypad displays the current armed condition of areas within your security system.

The keypad displays When

PERIMETER ON The perimeter areas are on

ALL SYSTEM ON All areas are on

PERIM/INT ON The perimeter and interior areas are on but the bedroom area is off

Status List

The keypad Status List displays any alarm or trouble condition on a zone and any trouble condition that occurs with the AC power or battery power. If more than one alarm or trouble condition occurs at the same time, the keypad sequences this information on its display.

If your system contains any Panic zones, these are *not* displayed on the keypad for security reasons.

If an alarm occurs on a non-fire 24 hour zone or a system monitor, it remains in the Status List until it restores. If one or more armed burglary zones trips, the last one to trip remains in the Status List. The burglary zone alarm remains in the Status List for several minutes or until it's cleared by disarming the system.

Exit Error

This is an automatic function of the panel that prevents an alarm from occurring if an exit door doesn't close all the way after the system has been armed. Here's how it works:

You close all doors and windows, arm the system, and then leave by the front door. You close the door but it doesn't latch and opens slightly causing the front door zone to show as an open to the system. After the exit delay time expires the system attempts to arm the front door zone but recognizes the open condition and, instead of sending an alarm report to the central station, sends an Exit Error report and force arms the door. (If the door closes at a later time it will be included back into the system.) The system sounds the alarm sirens for 15 seconds to alert you of the condition and provide an opportunity for you to close the door.

The Exit Error feature allows the central station to acknowledge the arming error without dispatching the police on a false alarm.

How your System Operates

Your system has been programmed to operate in one of three modes: Area Arming, All/Perimeter, or Home/Sleep/Away.

- **Area Arming** - Your burglary protection is divided into up to four areas. Each area can have a custom name, be turned on or off independently of other areas, and limit access to only those users with the proper authority.
- **All/Perimeter** - Your burglary protection is divided into two areas: Interior and Perimeter. You can turn on the just the Perimeter protection while inside for security or turn on both as you leave.
- **Home/Sleep/Away** - Your burglary protection is divided into three areas: Interior, Perimeter, and Bedrooms. You can turn on the Perimeter, Perimeter and Interior, or all three areas separately.

Regardless of which mode has been programmed, much of the operation is similar. Throughout this guide, any differences between the systems are noted for your convenience.

Arming Functions

Bypassing: After making your arming selection, the keypad displays any zones that have been bypassed while the system was disarmed. These zones remain bypassed until the system is disarmed. Any 24 hour zones in a bad condition are also displayed.

During arming, the system verifies that all doors, windows, and other protection devices to be armed are in normal condition. If everything is okay, the system arms. If there is a problem on one or more burglary zones the keypad displays the problem and allows you to bypass those zones.

6 Introduction

How your System Operates

Your system has been programmed to operate in one of three modes: Area Arming, All/Perimeter, or Home/Sleep/Away.

- **Area Arming** - Your burglary protection is divided into up to four areas. Each area can have a custom name, be turned on or off independently of other areas, and limit access to only those users with the proper authority.
- **All/Perimeter** - Your burglary protection is divided into two areas: Interior and Perimeter. You can turn on the just the Perimeter protection while inside for security or turn on both as you leave.
- **Home/Sleep/Away** - Your burglary protection is divided into three areas: Interior, Perimeter, and Bedrooms. You can turn on the Perimeter, Perimeter and Interior, or all three areas separately.

Regardless of which mode has been programmed, much of the operation is similar. Throughout this guide, any differences between the systems are noted for your convenience.

Arming Functions

Bypassing: After making your arming selection, the keypad displays any zones that have been bypassed while the system was disarmed. These zones remain bypassed until the system is disarmed. Any 24 hour zones in a bad condition are also displayed.

During arming, the system verifies that all doors, windows, and other protection devices to be armed are in normal condition. If everything is okay, the system arms. If there is a problem on one or more burglary zones the keypad displays the problem and allows you to bypass those zones.

6 Introduction

If the problem can be corrected by closing a door or window, do not bypass the zone. Instead, correct the problem and try arming again. If the problem cannot be corrected, you can bypass the zone or wait until the zone can be repaired by a service technician. A bypassed zone is ignored by the system during the armed period.

In some cases, you might see the keypad display **FRONT DOOR BAD ***. The asterisk next to **BAD** means that the zone is a priority zone, which cannot be bypassed. The problem on the zone must be corrected before the system can be armed.

Armed Message: After all bypassing is completed or zone faults corrected, the areas you selected are armed. The keypad briefly displays **ALL SYSTEM ON** if all areas in the system are arming and **PERIMETER ON** or **PERIM/INT ON** if only selected areas are arming. The keypad then displays the exit delay as it counts down. Zones are not armed until the exit delay time expires.

If your system uses a keyswitch to arm an area, the exit delay time is NOT shown on the keypad display.

DIALING . . . Message: If your system is monitored, it may be programmed to wait for the arming report to be sent to the central station before displaying the armed message. See Arming Report below. This is to verify your phone lines are working properly. While the system is waiting, the display reads **DIALING....** If the report is received, the keypad buzzes for one second and displays the armed message. If the report is not received, the keypad displays **LOCAL ALARM ONLY** before displaying the armed message.

Arming Report: Your system can be programmed to send arming or zone bypassing reports to a central station. This feature is optional and can be programmed for you at any time.

If the problem can be corrected by closing a door or window, do not bypass the zone. Instead, correct the problem and try arming again. If the problem cannot be corrected, you can bypass the zone or wait until the zone can be repaired by a service technician. A bypassed zone is ignored by the system during the armed period.

In some cases, you might see the keypad display **FRONT DOOR BAD ***. The asterisk next to **BAD** means that the zone is a priority zone, which cannot be bypassed. The problem on the zone must be corrected before the system can be armed.

Armed Message: After all bypassing is completed or zone faults corrected, the areas you selected are armed. The keypad briefly displays **ALL SYSTEM ON** if all areas in the system are arming and **PERIMETER ON** or **PERIM/INT ON** if only selected areas are arming. The keypad then displays the exit delay as it counts down. Zones are not armed until the exit delay time expires.

If your system uses a keyswitch to arm an area, the exit delay time is NOT shown on the keypad display.

DIALING . . . Message: If your system is monitored, it may be programmed to wait for the arming report to be sent to the central station before displaying the armed message. See Arming Report below. This is to verify your phone lines are working properly. While the system is waiting, the display reads **DIALING....** If the report is received, the keypad buzzes for one second and displays the armed message. If the report is not received, the keypad displays **LOCAL ALARM ONLY** before displaying the armed message.

Arming Report: Your system can be programmed to send arming or zone bypassing reports to a central station. This feature is optional and can be programmed for you at any time.

Area System Arming

Area Assignment: Your security system has been programmed into separate areas. The number of areas and their names are listed in the back of this guide.

Arming or Disarming: You can arm and disarm all areas at one time or each area individually. You can only arm or disarm areas authorized for your user code.

All or Selective Arming: After entering your user code, the system allows you to arm either all of the areas to which you have access or one or more selected areas. If you choose to arm all areas, the system begins verifying that all zones in those areas are in a good condition. If you choose to arm selected areas, the system prompts you to choose the areas you want to arm.

Arming the System

1. Press the COMMAND key until **ARM DISARM** displays.
2. Select **ARM** to turn on all protection.
3. Enter your user code if required. The display reads **ALL? NO YES**.
4. Select **NO** to arm only selected areas. Go to step 5. Select **YES** to arm all areas authorized for your user code.
5. If **NO** is selected in step 4, the display begins to list each area to which you have access followed by **NO YES**.
Example: **OFFICE NO YES**.
 - 5a. Select **YES** for each area you want to arm.
 - 5b. Select **NO** for each area you do NOT want to arm.

Note: You can also just press the area numbers you want to arm while at the **ALL? NO YES** display. This changes the display to **AREAS:**. The numbers you select appear in the display. For example: **AREAS: 2 4**. Press COMMAND when done.

6. The system displays any zones that have been bypassed prior to arming and any bad 24 hour zones. No action is required.
7. At this point you can **force arm** or **bypass** any bad zones. A zone that is force armed will be restored into the system if it later returns to normal. A zone that is bypassed will remain bypassed until the system is disarmed. See steps 7a through 7d.
 - 7a. If a problem exists on any zones, the zone name and problem are shown followed by: **OKAY BYPASS STOP**.
 - 7b. Select **OKAY** to force arm the zone(s) before arming.
 - 7c. Select **BYPASS** to bypass the zone(s) before arming.
 - 7d. Select **STOP** to stop the system from arming. Correct the zone problem(s) and return to step 1.
8. The display reads **SYSTEM ON** if at least one area in the system is armed, and **ALL SYSTEM ON** if all areas in the system are armed.
9. The keypad then displays the exit time in seconds and counts down the remaining time: **EXIT: ## (## = seconds remaining)**. The exit zones arm when the delay time expires.

Arming and Disarming 7

Area System Arming

Area Assignment: Your security system has been programmed into separate areas. The number of areas and their names are listed in the back of this guide.

Arming or Disarming: You can arm and disarm all areas at one time or each area individually. You can only arm or disarm areas authorized for your user code.

All or Selective Arming: After entering your user code, the system allows you to arm either all of the areas to which you have access or one or more selected areas. If you choose to arm all areas, the system begins verifying that all zones in those areas are in a good condition. If you choose to arm selected areas, the system prompts you to choose the areas you want to arm.

Arming the System

1. Press the COMMAND key until **ARM DISARM** displays.
2. Select **ARM** to turn on all protection.
3. Enter your user code if required. The display reads **ALL? NO YES**.
4. Select **NO** to arm only selected areas. Go to step 5. Select **YES** to arm all areas authorized for your user code.
5. If **NO** is selected in step 4, the display begins to list each area to which you have access followed by **NO YES**.
Example: **OFFICE NO YES**.
 - 5a. Select **YES** for each area you want to arm.
 - 5b. Select **NO** for each area you do NOT want to arm.

Note: You can also just press the area numbers you want to arm while at the **ALL? NO YES** display. This changes the display to **AREAS:**. The numbers you select appear in the display. For example: **AREAS: 2 4**. Press COMMAND when done.

6. The system displays any zones that have been bypassed prior to arming and any bad 24 hour zones. No action is required.
7. At this point you can **force arm** or **bypass** any bad zones. A zone that is force armed will be restored into the system if it later returns to normal. A zone that is bypassed will remain bypassed until the system is disarmed. See steps 7a through 7d.
 - 7a. If a problem exists on any zones, the zone name and problem are shown followed by: **OKAY BYPASS STOP**.
 - 7b. Select **OKAY** to force arm the zone(s) before arming.
 - 7c. Select **BYPASS** to bypass the zone(s) before arming.
 - 7d. Select **STOP** to stop the system from arming. Correct the zone problem(s) and return to step 1.
8. The display reads **SYSTEM ON** if at least one area in the system is armed, and **ALL SYSTEM ON** if all areas in the system are armed.
9. The keypad then displays the exit time in seconds and counts down the remaining time: **EXIT: ## (## = seconds remaining)**. The exit zones arm when the delay time expires.

Arming and Disarming 7

Area System Disarming

Disarming: While the system is armed, you can only enter the premises through an exit/entry delay door without causing an alarm. After opening the door, the Security Command keypad sounds a prewarn tone to remind you to disarm the system. You must disarm the system before the delay time expires or an alarm on the door zone will occur.

During the prewarn tone, the keypad displays **ENTER CODE:** Enter your user code to disarm the system. Only those areas authorized for your user code will disarm.

All or Selective Arming: After entering your user code, the system allows you to disarm either all of the areas to which you have access or just selected areas. If you choose to disarm all areas, the system automatically disarms them. If you choose to disarm selected areas, the names of those areas will be displayed on the keypad.

Alarm Display: After disarming, the keypad displays any zones that went into alarm or any communication problems that occurred during the armed period. All burglary zones are then disarmed and any bypassed zones are automatically reset.

Disarmed Message: The keypad displays **ALL SYSTEM OFF** after the system disarms.

Central Station Report: A report of the disarming can be sent to the central station. If your system does not have this feature, it can be programmed for you at any time.

8 Arming and Disarming

Area System Disarming

Disarming: While the system is armed, you can only enter the premises through an exit/entry delay door without causing an alarm. After opening the door, the Security Command keypad sounds a prewarn tone to remind you to disarm the system. You must disarm the system before the delay time expires or an alarm on the door zone will occur.

During the prewarn tone, the keypad displays **ENTER CODE:** Enter your user code to disarm the system. Only those areas authorized for your user code will disarm.

All or Selective Arming: After entering your user code, the system allows you to disarm either all of the areas to which you have access or just selected areas. If you choose to disarm all areas, the system automatically disarms them. If you choose to disarm selected areas, the names of those areas will be displayed on the keypad.

Alarm Display: After disarming, the keypad displays any zones that went into alarm or any communication problems that occurred during the armed period. All burglary zones are then disarmed and any bypassed zones are automatically reset.

Disarmed Message: The keypad displays **ALL SYSTEM OFF** after the system disarms.

Central Station Report: A report of the disarming can be sent to the central station. If your system does not have this feature, it can be programmed for you at any time.

8 Arming and Disarming

Disarming an Area System

1. Press the COMMAND key until **ARM DISARM** is displayed. During entry delay this process starts at step 3 below.
2. Select **DISARM** to disarm areas.
3. The keypad displays **ENTER CODE:** . Enter your user code and press COMMAND. The keypad displays **ALL? NO YES**.
4. Select **YES** to disarm all areas authorized for your user code.
 - 4a. Select **NO** to disarm only certain areas individually. The keypad then displays the name of each area authorized for your code followed by the **NO YES** display.
 - 4b. Choose **YES** to disarm the area displayed.
 - 4c. Choose **NO** to not disarm and to display the next area.

Note: You can also just press the area numbers you want to disarm while at the **ALL? NO YES** display. This changes the display to **AREAS:** . The area numbers you select appear in the display. For example: **AREAS: 2 4**.

To remove an area number from the display, press its corresponding number on the keypad.

Press COMMAND when done.
5. After all areas have been displayed, any alarms or communication problems that occurred during the armed period are shown.
6. If all areas have been disarmed, the keypad displays **ALL SYSTEM OFF**.

Disarming an Area System

1. Press the COMMAND key until **ARM DISARM** is displayed. During entry delay this process starts at step 3 below.
2. Select **DISARM** to disarm areas.
3. The keypad displays **ENTER CODE:** . Enter your user code and press COMMAND. The keypad displays **ALL? NO YES**.
4. Select **YES** to disarm all areas authorized for your user code.
 - 4a. Select **NO** to disarm only certain areas individually. The keypad then displays the name of each area authorized for your code followed by the **NO YES** display.
 - 4b. Choose **YES** to disarm the area displayed.
 - 4c. Choose **NO** to not disarm and to display the next area.

Note: You can also just press the area numbers you want to disarm while at the **ALL? NO YES** display. This changes the display to **AREAS:** . The area numbers you select appear in the display. For example: **AREAS: 2 4**.

To remove an area number from the display, press its corresponding number on the keypad.

Press COMMAND when done.
5. After all areas have been displayed, any alarms or communication problems that occurred during the armed period are shown.
6. If all areas have been disarmed, the keypad displays **ALL SYSTEM OFF**.

All/Perimeter System Arming

Area Assignment: Your security system is divided into two separate areas. Motion detectors, inside doors, and other interior protection devices are assigned to the *Interior* area while windows and exterior doors are assigned to the *Perimeter* area.

Perimeter or All: When arming an All/Perimeter system, the keypad displays **PERIM ALL**. If you select **ALL**, you arm both the Perimeter and the Interior of the system. You'll want to arm both of these areas when leaving with nobody left inside. Selecting **PERIM** arms only the Perimeter of the system. Perimeter arming is for when you're staying inside but want the comfort of knowing the exterior doors and windows are armed. Perimeter arming allows you to move freely about inside without setting off any interior alarms.

System Ready/System Not Ready Keypad Displays

When all zones in the system are in a normal condition, the keypad displays **SYSTEM READY**. If there are one or more zones that are not in a normal condition, the keypad displays **SYSTEM NOT READY**. Pressing any top row SELECT key during this display shows the zone name allowing you to investigate the problem.

Instant Arming

Instant: During the exit delay time, you can cancel the exit and entry delays and cause all zones to be instant zones. Just press the far right select key under **INSTNT** while the exit delay is displayed. This immediately arms the exit zones. However, no entry delay is provided and an alarm will occur should an entry door be opened.

Arming an All/Perimeter System

1. Enter your code. The keypad displays **PERIM ALL**.
2. Select **PERIM** to arm the Perimeter area only.

All/Perimeter System Arming

Area Assignment: Your security system is divided into two separate areas. Motion detectors, inside doors, and other interior protection devices are assigned to the *Interior* area while windows and exterior doors are assigned to the *Perimeter* area.

Perimeter or All: When arming an All/Perimeter system, the keypad displays **PERIM ALL**. If you select **ALL**, you arm both the Perimeter and the Interior of the system. You'll want to arm both of these areas when leaving with nobody left inside. Selecting **PERIM** arms only the Perimeter of the system. Perimeter arming is for when you're staying inside but want the comfort of knowing the exterior doors and windows are armed. Perimeter arming allows you to move freely about inside without setting off any interior alarms.

System Ready/System Not Ready Keypad Displays

When all zones in the system are in a normal condition, the keypad displays **SYSTEM READY**. If there are one or more zones that are not in a normal condition, the keypad displays **SYSTEM NOT READY**. Pressing any top row SELECT key during this display shows the zone name allowing you to investigate the problem.

Instant Arming

Instant: During the exit delay time, you can cancel the exit and entry delays and cause all zones to be instant zones. Just press the far right select key under **INSTNT** while the exit delay is displayed. This immediately arms the exit zones. However, no entry delay is provided and an alarm will occur should an entry door be opened.

Arming an All/Perimeter System

1. Enter your user code. The keypad displays **PERIM ALL**.
2. Select **PERIM** to arm the Perimeter area only.

3. Select **ALL** to arm both the Perimeter and Interior areas.
4. The keypad displays any bypassed zones and 24 hour zones that are in a bad condition. No action is required by you.
5. At this point you can **force arm** or **bypass** any bad zones. A zone that is force armed will be restored into the system if it later returns to normal. A zone that is bypassed will remain bypassed until the system is disarmed. See steps 5a through 5d.
 - 5a. If a problem exists on any zones, the zone name and problem are shown followed by: **OKAY BYPASS STOP**.
 - 5b. Select **OKAY** to force arm the zone(s) before arming.
 - 5c. Select **BYPASS** to bypass the zone(s) before arming.
 - 5d. Select **STOP** to stop the system from arming. Correct the zone problem(s) and return to step 1.
6. The keypad displays **PERIMETER ON** if only the perimeter is being armed and **ALL SYSTEM ON** if both the perimeter and interior are being armed.
7. The keypad next displays **EXIT: ## INSTNT** and begins to count down the number of seconds remaining for you to exit. When the delay expires, all zones are armed.
8. You can select **INSTNT** while **EXIT: ## INSTNT** is displayed to immediately arm all zones and make them instant. The keypad displays **INSTANT**.
9. When the system is fully armed, the keypad displays **PERIMETER ON** for perimeter arming and **ALL SYSTEM ON** for perimeter and interior arming.

Arming and Disarming 9

3. Select **ALL** to arm both the Perimeter and Interior areas.
4. The keypad displays any bypassed zones and 24 hour zones that are in a bad condition. No action is required by you.
5. At this point you can **force arm** or **bypass** any bad zones. A zone that is force armed will be restored into the system if it later returns to normal. A zone that is bypassed will remain bypassed until the system is disarmed. See steps 5a through 5d.
 - 5a. If a problem exists on any zones, the zone name and problem are shown followed by: **OKAY BYPASS STOP**.
 - 5b. Select **OKAY** to force arm the zone(s) before arming.
 - 5c. Select **BYPASS** to bypass the zone(s) before arming.
 - 5d. Select **STOP** to stop the system from arming. Correct the zone problem(s) and return to step 1.
6. The keypad displays **PERIMETER ON** if only the perimeter is being armed and **ALL SYSTEM ON** if both the perimeter and interior are being armed.
7. The keypad next displays **EXIT: ## INSTNT** and begins to count down the number of seconds remaining for you to exit. When the delay expires, all zones are armed.
8. You can select **INSTNT** while **EXIT: ## INSTNT** is displayed to immediately arm all zones and make them instant. The keypad displays **INSTANT**.
9. When the system is fully armed, the keypad displays **PERIMETER ON** for perimeter arming and **ALL SYSTEM ON** for perimeter and interior arming.

Arming and Disarming 9

All/Perimeter System Disarming

Disarming: While the system is armed, you can only enter the premises through an entry/exit delay door without causing an alarm. After opening the door, the Security Command keypad sounds a prewarn tone to remind you to disarm the system. You must disarm the system before the prewarn tone expires or an alarm on the door zone will occur.

During the prewarn tone, the keypad displays **ENTER CODE:**. Enter your user code to disarm the system.

Alarm Display: After disarming, the keypad displays any zones that tripped or any transmission problems that occurred during the armed period. All burglary zones are then disarmed and any bypassed zones are automatically reset.

Disarmed Message: The keypad displays **ALL SYSTEM OFF** after the system disarms.

Central Station Report: A report of the system disarming can be transmitted to the central station. This is optional and can be programmed for you at any time.

Disarming an All/Perimeter System

1. During the entry delay time, the keypad displays **ENTER CODE:** . Enter your user code.
2. The keypad then displays any zones that went into alarm or any communication problems that occurred during the armed period.
3. The keypad next displays **ALL SYSTEM OFF** to confirm the system is disarmed.

Disarming During an Alarm

1. While the alarm bell or siren is sounding, enter your user code. The keypad displays **DISARM SILENCE**.
2. Press the SELECT key under **DISARM** to disarm the system and silence the alarm.
The keypad next displays **ALL SYSTEM OFF** to confirm the system is disarmed.
3. Press the SELECT key under **SILENCE** to stop the bell or siren but NOT disarm the system.
If you do not press any SELECT key, or you press the COMMAND key, the system will automatically disarm and silence the alarm.
4. If your system is programmed to send an Abort (alarm cancel) report to the central station, the keypad displays **ALARM CANCELLED**.

10 Arming and Disarming

All/Perimeter System Disarming

Disarming: While the system is armed, you can only enter the premises through an entry/exit delay door without causing an alarm. After opening the door, the Security Command keypad sounds a prewarn tone to remind you to disarm the system. You must disarm the system before the prewarn tone expires or an alarm on the door zone will occur.

During the prewarn tone, the keypad displays **ENTER CODE:**. Enter your user code to disarm the system.

Alarm Display: After disarming, the keypad displays any zones that tripped or any transmission problems that occurred during the armed period. All burglary zones are then disarmed and any bypassed zones are automatically reset.

Disarmed Message: The keypad displays **ALL SYSTEM OFF** after the system disarms.

Central Station Report: A report of the system disarming can be transmitted to the central station. This is optional and can be programmed for you at any time.

Disarming an All/Perimeter System

1. During the entry delay time, the keypad displays **ENTER CODE:** . Enter your user code.
2. The keypad then displays any zones that went into alarm or any communication problems that occurred during the armed period.
3. The keypad next displays **ALL SYSTEM OFF** to confirm the system is disarmed.

Disarming During an Alarm

1. While the alarm bell or siren is sounding, enter your user code. The keypad displays **DISARM SILENCE**.
2. Press the SELECT key under **DISARM** to disarm the system and silence the alarm.
The keypad next displays **ALL SYSTEM OFF** to confirm the system is disarmed.
3. Press the SELECT key under **SILENCE** to stop the bell or siren but NOT disarm the system.
If you do not press any SELECT key, or you press the COMMAND key, the system will automatically disarm and silence the alarm.
4. If your system is programmed to send an Abort (alarm cancel) report to the central station, the keypad displays **ALARM CANCELLED**.

10 Arming and Disarming

Home/Away System Arming

Area Assignment: Your security system is divided into two or three separate areas. Motion detectors, inside doors, and other interior devices are assigned to an *Interior* and possibly *Bedroom* area while windows and exterior doors, are assigned to a *Perimeter* area.

Arming the system: When arming a Home/Away system, the keypad displays **HOME AWAY** or **HOME SLEEP AWAY**. If you select **AWAY**, you arm all areas of the system. You'll want to arm all areas when leaving with nobody staying inside. Selecting **HOME** arms only the Perimeter of the system. Perimeter arming is for when you're staying inside but want the comfort of knowing the exterior doors and windows are armed. Selecting **SLEEP** arms the Perimeter and Interior devices but leaves devices near bedrooms or other nighttime areas off.

System Ready/System Not Ready Keypad Displays

When all zones in the system are in a normal condition and can be armed without bypassing, the keypad displays **SYSTEM READY**. If there are one or more zones that are not in a normal condition, the keypad displays **SYSTEM NOT READY**. Pressing any top row SELECT key during this display shows the bad zone name.

Arming a Home/Away System

1. Enter your 4-digit user code. The keypad displays **HOME AWAY** or **HOME SLEEP AWAY** (you may have three areas).
2. Select **HOME** to arm the Perimeter only.
3. Select **SLEEP** to arm the Perimeter and Interior.
4. Select **AWAY** to arm the Perimeter, Interior, and Bedroom.

Home/Away System Arming

Area Assignment: Your security system is divided into two or three separate areas. Motion detectors, inside doors, and other interior devices are assigned to an *Interior* and possibly *Bedroom* area while windows and exterior doors, are assigned to a *Perimeter* area.

Arming the system: When arming a Home/Away system, the keypad displays **HOME AWAY** or **HOME SLEEP AWAY**. If you select **AWAY**, you arm all areas of the system. You'll want to arm all areas when leaving with nobody staying inside. Selecting **HOME** arms only the Perimeter of the system. Perimeter arming is for when you're staying inside but want the comfort of knowing the exterior doors and windows are armed. Selecting **SLEEP** arms the Perimeter and Interior devices but leaves devices near bedrooms or other nighttime areas off.

System Ready/System Not Ready Keypad Displays

When all zones in the system are in a normal condition and can be armed without bypassing, the keypad displays **SYSTEM READY**. If there are one or more zones that are not in a normal condition, the keypad displays **SYSTEM NOT READY**. Pressing any top row SELECT key during this display shows the bad zone name.

Arming a Home/Away System

1. Enter your 4-digit user code. The keypad displays **HOME AWAY** or **HOME SLEEP AWAY** (you may have three areas).
2. Select **HOME** to arm the Perimeter only.
3. Select **SLEEP** to arm the Perimeter and Interior.
4. Select **AWAY** to arm the Perimeter, Interior, and Bedroom.

5. The keypad displays zones that have been bypassed prior to arming and 24 hour zones that are in a bad condition. No action is required by you.
5. At this point you can **force arm** or **bypass** any bad zones. A zone that is force armed will be restored into the system if it later returns to normal. A zone that is bypassed will remain bypassed until the system is disarmed. See steps 5a through 5d.
 - 5a. If a problem exists on any zones, the zone name and problem are shown followed by: **OKAY BYPASS STOP**.
 - 5b. Select **OKAY** to force arm the zone(s) before arming.
 - 5c. Select **BYPASS** to bypass the zone(s) before arming.
 - 5d. Select **STOP** to stop the system from arming. Correct the zone problem(s) and return to step 1.
7. The keypad displays **PERIMETER ON** if you selected **HOME**, or **PERIM/INT ON** if you selected **SLEEP**, or **ALL SYSTEM ON** if you selected **AWAY**.
8. The keypad next displays **EXIT: ## INSTNT** and begins to count down the number of seconds remaining for you to exit. When the delay expires, all zones are armed.
9. You can select **INSTNT** while **EXIT: ## INSTNT** is displayed to immediately arm all zones and make them instant. The keypad displays **INSTANT**.
10. When the system is fully armed, the keypad displays **PERIMETER ON** for Perimeter arming, **PERIM/INT ON** for Perimeter and Interior arming, and **ALL SYSTEM ON** for all areas armed.

5. The keypad displays zones that have been bypassed prior to arming and 24 hour zones that are in a bad condition. No action is required by you.
5. At this point you can **force arm** or **bypass** any bad zones. A zone that is force armed will be restored into the system if it later returns to normal. A zone that is bypassed will remain bypassed until the system is disarmed. See steps 5a through 5d.
 - 5a. If a problem exists on any zones, the zone name and problem are shown followed by: **OKAY BYPASS STOP**.
 - 5b. Select **OKAY** to force arm the zone(s) before arming.
 - 5c. Select **BYPASS** to bypass the zone(s) before arming.
 - 5d. Select **STOP** to stop the system from arming. Correct the zone problem(s) and return to step 1.
7. The keypad displays **PERIMETER ON** if you selected **HOME**, or **PERIM/INT ON** if you selected **SLEEP**, or **ALL SYSTEM ON** if you selected **AWAY**.
8. The keypad next displays **EXIT: ## INSTNT** and begins to count down the number of seconds remaining for you to exit. When the delay expires, all zones are armed.
9. You can select **INSTNT** while **EXIT: ## INSTNT** is displayed to immediately arm all zones and make them instant. The keypad displays **INSTANT**.
10. When the system is fully armed, the keypad displays **PERIMETER ON** for Perimeter arming, **PERIM/INT ON** for Perimeter and Interior arming, and **ALL SYSTEM ON** for all areas armed.

Home/Away System Disarming

Disarming: While the system is armed, you can only enter the premises through an entry/exit delay door without causing an alarm. After opening the door, the keypad sounds a prewarn tone to remind you to disarm the system. You must disarm the system before the prewarn tone expires or an alarm on the door zone will occur.

During the prewarn tone, the keypad displays **ENTER CODE:.** Enter your code to disarm the system.

Alarm Display: After disarming, the keypad displays any zones that tripped or any communication problems that occurred during the armed period. All burglary zones are then disarmed and any bypassed zones are automatically reset.

Disarmed Message: The keypad displays **ALL SYSTEM OFF** after the system disarms.

Central Station Report: A report of the system disarming can be transmitted to the central station. This is optional and can be programmed for you at any time.

Easy Exit™ Feature

While the system is armed, you can also just press the COMMAND and then the 9 key to restart the exit delays to allow you to exit the premises without disarming the system. After the exit delay time expires, the system rearms automatically. This feature allows you to get the paper, let your pet out, or leave for work without having to disarm and then rearm the system.

Disarming a Home/Away System

1. During the entry delay, the keypad displays **ENTER CODE:.** Enter your 4 digit user code.
2. The keypad then displays any alarms or communication problems that occurred during the armed period.
3. The keypad next displays **ALL SYSTEM OFF** to confirm the system is disarmed.

Disarming During an Alarm

1. While the alarm bell or siren is sounding, enter your 4 digit user code. The keypad displays **DISARM SILENCE.**
2. Press the SELECT key under **DISARM** to disarm the system and silence the alarm.

The keypad next displays **ALL SYSTEM OFF** to confirm the system is disarmed.

3. Press the SELECT key under **SILENCE** to stop the bell or siren but NOT disarm the system.

If you do not press any SELECT key, or you press the COMMAND key, the system will automatically disarm and silence the alarm.

4. If your system is programmed to send an Abort (alarm cancel) report to the central station, the keypad displays **ALARM CANCELLED.**

12 Arming and Disarming

Home/Away System Disarming

Disarming: While the system is armed, you can only enter the premises through an entry/exit delay door without causing an alarm. After opening the door, the keypad sounds a prewarn tone to remind you to disarm the system. You must disarm the system before the prewarn tone expires or an alarm on the door zone will occur.

During the prewarn tone, the keypad displays **ENTER CODE:.** Enter your code to disarm the system.

Alarm Display: After disarming, the keypad displays any zones that tripped or any communication problems that occurred during the armed period. All burglary zones are then disarmed and any bypassed zones are automatically reset.

Disarmed Message: The keypad displays **ALL SYSTEM OFF** after the system disarms.

Central Station Report: A report of the system disarming can be transmitted to the central station. This is optional and can be programmed for you at any time.

Easy Exit™ Feature

While the system is armed, you can also just press the COMMAND and then the 9 key to restart the exit delays to allow you to exit the premises without disarming the system. After the exit delay time expires, the system rearms automatically. This feature allows you to get the paper, let your pet out, or leave for work without having to disarm and then rearm the system.

Disarming a Home/Away System

1. During the entry delay, the keypad displays **ENTER CODE:.** Enter your 4 digit user code.
2. The keypad then displays any alarms or communication problems that occurred during the armed period.
3. The keypad next displays **ALL SYSTEM OFF** to confirm the system is disarmed.

Disarming During an Alarm

1. While the alarm bell or siren is sounding, enter your 4 digit user code. The keypad displays **DISARM SILENCE.**
2. Press the SELECT key under **DISARM** to disarm the system and silence the alarm.

The keypad next displays **ALL SYSTEM OFF** to confirm the system is disarmed.

3. Press the SELECT key under **SILENCE** to stop the bell or siren but NOT disarm the system.

If you do not press any SELECT key, or you press the COMMAND key, the system will automatically disarm and silence the alarm.

4. If your system is programmed to send an Abort (alarm cancel) report to the central station, the keypad displays **ALARM CANCELLED.**

12 Arming and Disarming

Security Command User Menu

Many of the features of your system have been put into a User Menu you can access from any Security Command keypad.

To access the User Menu:

1. Press the COMMAND key until **MENU? NO YES** displays.
2. Select **YES**. The keypad displays **ENTER CODE: –**. Enter your user code. You can now scroll down through the list of system features available to your authority level.

The following pages detail each User Menu item and provide instructions on when and how to use them properly.

User Checkin

User Code Level: Master or Standard

Function: This feature allows you to monitor the arrival of latchkey children or employees by having a special **Checkin Report** sent to your alphanumeric or numeric pager. Your system must be programmed for the Pager Direct™ option. The Appendix section of this guide contains Quick Reference cards for your wallet or purse.

Sending a Checkin Report:

1. After disarming the system, access the User Menu.
(Or press the COMMAND then 7 key and enter your user code to send a Checkin Report. This feature operates on 32-character keypads only.)
2. At the **USER CHECKIN?** display, press any SELECT key. The keypad displays **USER CHECKIN: 22** (22 = user number).
3. The panel sends the Checkin Report containing your account number and user number to the pager.

Security Command User Menu

Many of the features of your system have been put into a User Menu you can access from any Security Command keypad.

To access the User Menu:

1. Press the COMMAND key until **MENU? NO YES** displays.
2. Select **YES**. The keypad displays **ENTER CODE: –**. Enter your user code. You can now scroll down through the list of system features available to your authority level.

The following pages detail each User Menu item and provide instructions on when and how to use them properly.

User Checkin

User Code Level: Master or Standard

Function: This feature allows you to monitor the arrival of latchkey children or employees by having a special **Checkin Report** sent to your alphanumeric or numeric pager. Your system must be programmed for the Pager Direct™ option. The Appendix section of this guide contains Quick Reference cards for your wallet or purse.

Sending a Checkin Report:

1. After disarming the system, access the User Menu.
(Or press the COMMAND then 7 key and enter your user code to send a Checkin Report. This feature operates on 32-character keypads only.)
2. At the **USER CHECKIN?** display, press any SELECT key. The keypad displays **USER CHECKIN: 22** (22 = user number).
3. The panel sends the Checkin Report containing your account number and user number to the pager.

Sensor Reset

User Code Level: Master or Standard

Function: Resets smoke or glassbreak detectors. Also clears Fire and Supervisory zone alarm and trouble keypad displays. Sensor Reset also clears low battery displays if your system is using wireless sensors.

Once smoke or glassbreak detectors have tripped, they must be reset before they can detect any additional alarm conditions. When Sensor Reset is selected, power to the detectors is temporarily removed by the system allowing them to reset.

Make sure all smoke is cleared from around the area of the smoke detectors before performing a Sensor Reset to prevent the alarm from occurring again.

Resetting the Sensors

1. Access the User Menu.
2. When **SENSOR RESET?** is displayed, press any SELECT key. The keypad displays **SENSORS OFF** for five seconds followed by **SENSORS ON**.
3. The keypad returns to the status display.

Enter your user code to reset sensors

While your system is disarmed, you can just enter your user code and press COMMAND to reset the sensors. (This feature operates in All/Perimeter and Home/Away systems only.)

This also activates the door strike if your system has an Easy Entry™ access control keypad.

User Menu 13

Sensor Reset

User Code Level: Master or Standard

Function: Resets smoke or glassbreak detectors. Also clears Fire and Supervisory zone alarm and trouble keypad displays. Sensor Reset also clears low battery displays if your system is using wireless sensors.

Once smoke or glassbreak detectors have tripped, they must be reset before they can detect any additional alarm conditions. When Sensor Reset is selected, power to the detectors is temporarily removed by the system allowing them to reset.

Make sure all smoke is cleared from around the area of the smoke detectors before performing a Sensor Reset to prevent the alarm from occurring again.

Resetting the Sensors

1. Access the User Menu.
2. When **SENSOR RESET?** is displayed, press any SELECT key. The keypad displays **SENSORS OFF** for five seconds followed by **SENSORS ON**.
3. The keypad returns to the status display.

Enter your user code to reset sensors

While your system is disarmed, you can just enter your user code and press COMMAND to reset the sensors. (This feature operates in All/Perimeter and Home/Away systems only.)

This also activates the door strike if your system has an Easy Entry™ access control keypad.

User Menu 13

Outputs On Off

User Code Level: Master or Standard.

Function: Allows you to turn the system's outputs on and off.

This function is used to individually turn your system's relay outputs on and off. Your system may use these outputs to control interior and exterior lighting, or heating, air conditioning, or other appliances.

The names and numbers of the outputs on your system are located in the System Setup section at the back of this guide.

Turning the Outputs On and Off

1. Access the User Menu.
2. Press the COMMAND key until **OUTPUTS ON/OFF?** displays.
3. Press any one of the SELECT keys.
4. The keypad displays **OUTPUT: - ON OFF**.
5. Enter the output number you want to turn on or off. The output number appears in the display.
6. With the output number displayed, press the SELECT key under **ON** or **OFF**. The output is then turned on or off, depending on your selection, and remains in that state until you change it.
7. The system automatically removes the output number and a new output number can be entered. Refer back to step 5.

To exit the Output menu option, press the ARROW key until you've returned to the keypad's Status List.

14 User Menu

Outputs On Off

User Code Level: Master or Standard.

Function: Allows you to turn the system's outputs on and off.

This function is used to individually turn your system's relay outputs on and off. Your system may use these outputs to control interior and exterior lighting, or heating, air conditioning, or other appliances.

The names and numbers of the outputs on your system are located in the System Setup section at the back of this guide.

Turning the Outputs On and Off

1. Access the User Menu.
2. Press the COMMAND key until **OUTPUTS ON/OFF?** displays.
3. Press any one of the SELECT keys.
4. The keypad displays **OUTPUT: - ON OFF**.
5. Enter the output number you want to turn on or off. The output number appears in the display.
6. With the output number displayed, press the SELECT key under **ON** or **OFF**. The output is then turned on or off, depending on your selection, and remains in that state until you change it.
7. The system automatically removes the output number and a new output number can be entered. Refer back to step 5.

To exit the Output menu option, press the ARROW key until you've returned to the keypad's Status List.

14 User Menu

Bypass Zones

User Code Level: Master or Standard.

Function: Allows you to bypass a zone prior to arming the system.

Bypassing is usually done when a zone cannot be restored to normal and you want to arm the system. Once bypassed, the system will not respond to any activity on the zone.

A zone can be bypassed only while it's disarmed. Since Fire, Panic, Emergency, and Supervisory zones are always armed, they can never be bypassed.

The Bypass Zones function can also be used to restore a bypassed zone back into the system. This can only be done while the zone is disarmed.

When Bypass Zones is selected, a report of the bypassing can be sent to your central station. This is optional and can be programmed for you at any time.

Using the Bypass Zones Function

1. Access the User Menu.
2. Press the COMMAND key until **BYPASS ZONES?** displays.
3. Press any one of the SELECT keys. The keypad displays **ZONE: - RST BYPS**.
4. To reset a zone, enter the zone number and press the SELECT key under **RST**.
5. To Bypass a zone, enter the zone number and press the SELECT key under **BYPS**.

Bypass Zones

User Code Level: Master or Standard.

Function: Allows you to bypass a zone prior to arming the system.

Bypassing is usually done when a zone cannot be restored to normal and you want to arm the system. Once bypassed, the system will not respond to any activity on the zone.

A zone can be bypassed only while it's disarmed. Since Fire, Panic, Emergency, and Supervisory zones are always armed, they can never be bypassed.

The Bypass Zones function can also be used to restore a bypassed zone back into the system. This can only be done while the zone is disarmed.

When Bypass Zones is selected, a report of the bypassing can be sent to your central station. This is optional and can be programmed for you at any time.

Using the Bypass Zones Function

1. Access the User Menu.
2. Press the COMMAND key until **BYPASS ZONES?** displays.
3. Press any one of the SELECT keys. The keypad displays **ZONE: - RST BYPS**.
4. To reset a zone, enter the zone number and press the SELECT key under **RST**.
5. To Bypass a zone, enter the zone number and press the SELECT key under **BYPS**.

Zone Monitor

User Code Level: Master and Standard.

Function: Allows the system to monitor selected disarmed zones (doors, windows, or motion detectors). When a monitored zone is tripped, the keypad sounds a tone and displays the zone name. This is an ideal feature for monitoring door zones to tell when someone comes in or goes out.

You can place any combination of disarmed zones in Zone Monitor but only the most recent zone tripped is displayed. The displayed zone name clears automatically after a short time or when the zone is armed.

Zone Monitor does not function while the system is armed but a zone placed into it will still be monitored when the system is disarmed.

Using Zone Monitor as part of your weekly system test: After using the System Test function (see page 16), place all perimeter and interior zones in Zone Monitor. Starting at the front door, go around and open and then close each door and window. You should hear the keypad beep each time. The keypad will also display the name of each zone as its device is opened.

Once all protected doors and windows have been tested, walk in front of each motion detector. The keypad should beep to confirm their operation. If at any time during your weekly testing a device does not cause the keypad to beep, call the service department for assistance.

Zone Monitor

User Code Level: Master and Standard.

Function: Allows the system to monitor selected disarmed zones (doors, windows, or motion detectors). When a monitored zone is tripped, the keypad sounds a tone and displays the zone name. This is an ideal feature for monitoring door zones to tell when someone comes in or goes out.

You can place any combination of disarmed zones in Zone Monitor but only the most recent zone tripped is displayed. The displayed zone name clears automatically after a short time or when the zone is armed.

Zone Monitor does not function while the system is armed but a zone placed into it will still be monitored when the system is disarmed.

Using Zone Monitor as part of your weekly system test: After using the System Test function (see page 16), place all perimeter and interior zones in Zone Monitor. Starting at the front door, go around and open and then close each door and window. You should hear the keypad beep each time. The keypad will also display the name of each zone as its device is opened.

Once all protected doors and windows have been tested, walk in front of each motion detector. The keypad should beep to confirm their operation. If at any time during your weekly testing a device does not cause the keypad to beep, call the service department for assistance.

Using the Zone Monitor Function

1. Access the User Menu.
2. Press the COMMAND key until **ZONE MONITOR?** displays.
3. Press any one of the SELECT keys.
The keypad displays **PERIM ALL NBR**.
4. Select **PERIM** to place all disarmed perimeter zones into Zone Monitor. **PERIM** is displayed only on All/Perimeter and Home/Away systems.
 - 4a. The keypad displays **PERIM? ADD RMV**.
 - 4b. Select **ADD** to add all perimeter zones to Zone Monitor.
 - 4c. Select **RMV** to remove all perimeter zones.
5. Select **ALL** to place all disarmed perimeter and interior zones into Zone Monitor.
 - 5a. The keypad displays **ALL? ADD RMV**.
 - 5b. Select **ADD** to add all disarmed zones to Zone Monitor.
 - 5c. Select **RMV** to remove all disarmed zones.
6. Select **NBR** to enter a specific zone number for zone monitor.
7. If **NBR** is selected, the keypad displays **ZONE : - ADD RMV**.
 - 7a. Enter any zone number and select **ADD** to add this zone.
 - 7b. Enter any zone number and select **RMV** to remove the zone.
8. The zone number automatically disappears and a new zone number can then be entered in step 7a.

User Menu 15

Using the Zone Monitor Function

1. Access the User Menu.
2. Press the COMMAND key until **ZONE MONITOR?** displays.
3. Press any one of the SELECT keys.
The keypad displays **PERIM ALL NBR**.
4. Select **PERIM** to place all disarmed perimeter zones into Zone Monitor. **PERIM** is displayed only on All/Perimeter and Home/Away systems.
 - 4a. The keypad displays **PERIM? ADD RMV**.
 - 4b. Select **ADD** to add all perimeter zones to Zone Monitor.
 - 4c. Select **RMV** to remove all perimeter zones.
5. Select **ALL** to place all disarmed perimeter and interior zones into Zone Monitor.
 - 5a. The keypad displays **ALL? ADD RMV**.
 - 5b. Select **ADD** to add all disarmed zones to Zone Monitor.
 - 5c. Select **RMV** to remove all disarmed zones.
6. Select **NBR** to enter a specific zone number for zone monitor.
7. If **NBR** is selected, the keypad displays **ZONE : - ADD RMV**.
 - 7a. Enter any zone number and select **ADD** to add this zone.
 - 7b. Enter any zone number and select **RMV** to remove the zone.
8. The zone number automatically disappears and a new zone number can then be entered in step 7a.

User Menu 15

System Test

User Code Level: Master or Standard.

Function: System Test is used to test the battery, alarm bell or siren, and communication to a central station. The System Test function begins automatically as soon as you select it.

Using the System Test Function

1. Access the User Menu.
 2. Press the COMMAND key until **SYSTEM TEST?** displays.
 3. Press any one of the SELECT keys. The system test begins automatically and the keypad displays:
 - 1) **BELL SOUNDING** during a two second bell test, then:
 - 2) **BATTERY - OKAY** or **BATTERY - TRBL** to indicate the condition of the battery, then:
 - * 3) **TRANSMIT TEST** and **ATTEMPT NO : 1** during the transmit test, then:
 - 4) **TRANSMIT OKAY** or **TRANSMIT FAILED** to show the results of the transmit test, then:
 - 5) **TEST END** to indicate the System Test is complete.
 - 6) You can end the transmit test by pressing the ARROW key.
- * The transmit test does not operate on local systems.

Testing your system's burglary protection: The System Test function should be part of your weekly testing and should be followed by placing the interior and perimeter burglary devices in Zone Monitor mode. This allows you to open and then close each protected door and window while listening for the keypad to beep confirming its operation. See Zone Monitor.

16 User Menu

System Test

User Code Level: Master or Standard.

Function: System Test is used to test the battery, alarm bell or siren, and communication to a central station. The System Test function begins automatically as soon as you select it.

Using the System Test Function

1. Access the User Menu.
 2. Press the COMMAND key until **SYSTEM TEST?** displays.
 3. Press any one of the SELECT keys. The system test begins automatically and the keypad displays:
 - 1) **BELL SOUNDING** during a two second bell test, then:
 - 2) **BATTERY - OKAY** or **BATTERY - TRBL** to indicate the condition of the battery, then:
 - * 3) **TRANSMIT TEST** and **ATTEMPT NO : 1** during the transmit test, then:
 - 4) **TRANSMIT OKAY** or **TRANSMIT FAILED** to show the results of the transmit test, then:
 - 5) **TEST END** to indicate the System Test is complete.
 - 6) You can end the transmit test by pressing the ARROW key.
- * The transmit test does not operate on local systems.

Testing your system's burglary protection: The System Test function should be part of your weekly testing and should be followed by placing the interior and perimeter burglary devices in Zone Monitor mode. This allows you to open and then close each protected door and window while listening for the keypad to beep confirming its operation. See Zone Monitor.

16 User Menu

User Codes

User Code Level: Master only.

Function: Allows you to add or delete a user from the system or change their user code or authority level.

There are three characteristics associated with each user code:

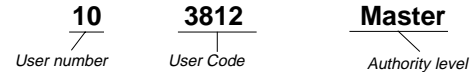

User Number - Your system supports 32 users. Each user is numbered from 1 to 32. This number identifies them to the system and is transmitted to the central station (if your system is monitored) when they arm or disarm the system.

User Code - Users also have a 4-digit user code they enter into the keypad when arming or disarming. This user code is kept secret from other users and is not transmitted to the central station when they arm or disarm.

A user enters *only* their user code when operating the system.

Authority Level - The user is also assigned a level of authority (Master or Standard) by the person administrating the system that determines the functions they can access.

The table to the right lists system functions users are allowed to access based on the authority level assigned to their codes at the time they're added to the system.

User Codes

User Code Level: Master only.

Function: Allows you to add or delete a user from the system or change their user code or authority level.

There are three characteristics associated with each user code:

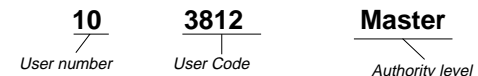

User Number - Your system supports 32 users. Each user is numbered from 1 to 32. This number identifies them to the system and is transmitted to the central station (if your system is monitored) when they arm or disarm the system.

User Code - Users also have a 4-digit user code they enter into the keypad when arming or disarming. This user code is kept secret from other users and is not transmitted to the central station when they arm or disarm.

A user enters *only* their user code when operating the system.

Authority Level - The user is also assigned a level of authority (Master or Standard) by the person administrating the system that determines the functions they can access.

The table to the right lists system functions users are allowed to access based on the authority level assigned to their codes at the time they're added to the system.

User Codes continued

User Code Authority Levels

System Options	Standard	Master
Sensor Reset	√	√
Outputs On/Off	√	√
Bypass Zones	√	√
Zone Monitor	√	√
System Test	√	√
Arm and Disarm	√	√
Display Events	√	√
Schedules		√
Date and Time		√
User Codes		√

Adding User codes:

1. Access the User Menu.
2. Press the COMMAND key until **USER CODES?** displays.
3. Press any SELECT key. The keypad displays **ADD DEL CHG**.
4. Press the SELECT key under **ADD** to add a new user code. (You must have a Master user level to add a user to the system.)
5. At the **USER NUMBER:** - prompt, enter a user number and press COMMAND. The display changes to **CODE NO:** .
6. Enter a user code of 4 digits and press COMMAND. This is the number the user will use each time they arm, disarm, or make changes to the system.

Note: If your system is using an access control reader, present the new user's access device instead of entering a user code.

User Codes continued

User Code Authority Levels

System Options	Standard	Master
Sensor Reset	√	√
Outputs On/Off	√	√
Bypass Zones	√	√
Zone Monitor	√	√
System Test	√	√
Arm and Disarm	√	√
Display Events	√	√
Schedules		√
Date and Time		√
User Codes		√

Adding User codes:

1. Access the User Menu.
2. Press the COMMAND key until **USER CODES?** displays.
3. Press any SELECT key. The keypad displays **ADD DEL CHG**.
4. Press the SELECT key under **ADD** to add a new user code. (You must have a Master user level to add a user to the system.)
5. At the **USER NUMBER:** - prompt, enter a user number and press COMMAND. The display changes to **CODE NO:** .
6. Enter a user code of 4 digits and press COMMAND. This is the number the user will use each time they arm, disarm, or make changes to the system.

Note: If your system is using an access control reader, present the new user's access device instead of entering a user code.

7. The display changes to **MASTER? NO YES**. Select **YES** to make this a Master user level with the authority to access all User Menu functions.

Select **NO** to make this a Standard user level. The following options can then be selected:

7a. TEMP CODE NO YES.

Select **NO** to make this a permanent user code.

Select **YES** to make this a temporary code that automatically expires in 7 days. Temporary codes are ideal for guests or service technicians. You can delete a Temporary user code at any time before the 7 day active period ends.

7b. AREAS: . (Displayed in Area systems only).

Enter the area numbers where this user will have access. For example: if you want this user to only have access to areas 1 and 2, enter the numbers 1 and 2.

Once the correct area numbers are shown, press Command.

7c. ARM ONLY NO YES.

Select **NO** to allow this user to arm and disarm the system and access all Standard level functions in the User Menu.

Select **YES** to restrict this user to arming only.

(The Arm Only user code can bypass zones not in a normal condition at the time of arming.)

8. After you've completed making your selections, the keypad display shows **USER # ADDED**.
9. Press the ARROW key once to add another user or twice to exit the User Menu.

7. The display changes to **MASTER? NO YES**. Select **YES** to make this a Master user level with the authority to access all User Menu functions.

Select **NO** to make this a Standard user level. The following options can then be selected:

7a. TEMP CODE NO YES.

Select **NO** to make this a permanent user code.

Select **YES** to make this a temporary code that automatically expires in 7 days. Temporary codes are ideal for guests or service technicians. You can delete a Temporary user code at any time before the 7 day active period ends.

7b. AREAS: . (Displayed in Area systems only).

Enter the area numbers where this user will have access. For example: if you want this user to only have access to areas 1 and 2, enter the numbers 1 and 2.

Once the correct area numbers are shown, press Command.

7c. ARM ONLY NO YES.

Select **NO** to allow this user to arm and disarm the system and access all Standard level functions in the User Menu.

Select **YES** to restrict this user to arming only.

(The Arm Only user code can bypass zones not in a normal condition at the time of arming.)

8. After you've completed making your selections, the keypad display shows **USER # ADDED**.
9. Press the ARROW key once to add another user or twice to exit the User Menu.

User Codes continued

Deleting User codes:

1. Access the User Menu.
2. Press the COMMAND key until **USER CODES?** displays.
3. Press any one of the SELECT keys. The keypad displays **ADD DEL CHG**.
4. Press the SELECT key under **DEL** to delete a user code from the system. You must have a Master user code level to be able to delete a user code.
5. At the **USER NUMBER:** - prompt, enter the user number you want to delete and press COMMAND. The display changes to **USER # DELETED**.
6. The display then changes back to **USER NUMBER:** - for you to delete another user. Press the ARROW key twice to exit the User Menu.

Ambush Codes

Your system may be programmed to allow user number 1 to be an Ambush code. The Ambush code functions identically to other codes with the exception that it sends a silent alarm to the central station. This silent alarm alerts the operator to a duress situation at the premises and prompts the immediate notification of the authorities.

Refer to the System Setup section of this guide to see if your system is programmed for Ambush. If so, do NOT program a code for user number 1 unless you intend to use the Ambush function.

18 User Menu

User Codes continued

Deleting User codes:

1. Access the User Menu.
2. Press the COMMAND key until **USER CODES?** displays.
3. Press any one of the SELECT keys. The keypad displays **ADD DEL CHG**.
4. Press the SELECT key under **DEL** to delete a user code from the system. You must have a Master user code level to be able to delete a user code.
5. At the **USER NUMBER:** - prompt, enter the user number you want to delete and press COMMAND. The display changes to **USER # DELETED**.
6. The display then changes back to **USER NUMBER:** - for you to delete another user. Press the ARROW key twice to exit the User Menu.

Ambush Codes

Your system may be programmed to allow user number 1 to be an Ambush code. The Ambush code functions identically to other codes with the exception that it sends a silent alarm to the central station. This silent alarm alerts the operator to a duress situation at the premises and prompts the immediate notification of the authorities.

Refer to the System Setup section of this guide to see if your system is programmed for Ambush. If so, do NOT program a code for user number 1 unless you intend to use the Ambush function.

18 User Menu

Changing User codes

1. Access the User Menu.
2. Press the COMMAND key until **USER CODES?** displays.
3. Press any one of the SELECT keys. The keypad displays **ADD DEL CHG**.
4. Press the SELECT key under **CHG** to change a user code. You must have a Master user code level to change a user code.
5. At the **USER NUMBER:** - prompt, enter the user number to change and press COMMAND.
6. The display changes to **CODE NO: * * * ***. Enter the new 4-digit user code and press COMMAND. If the code you entered is already in use, or is a code used internally by the system, the keypad displays **ALREADY IN USE**. You must enter a different 4-digit user code.
7. If you are changing a code other than your own, the keypad next displays **MASTER? NO YES**. Select **YES** if you want this user to have a Master authority level.

Select **NO** if you want this user to have a Standard authority level. If you select **NO**, refer to item number 7 in the Adding User Codes section on the previous page.

Important: Changing a user code does not change the user number. User number two may have their user code changed from 1234 to 5678 but they are still user number two.

Changing User codes

1. Access the User Menu.
2. Press the COMMAND key until **USER CODES?** displays.
3. Press any one of the SELECT keys. The keypad displays **ADD DEL CHG**.
4. Press the SELECT key under **CHG** to change a user code. You must have a Master user code level to change a user code.
5. At the **USER NUMBER:** - prompt, enter the user number to change and press COMMAND.
6. The display changes to **CODE NO: * * * ***. Enter the new 4-digit user code and press COMMAND. If the code you entered is already in use, or is a code used internally by the system, the keypad displays **ALREADY IN USE**. You must enter a different 4-digit user code.
7. If you are changing a code other than your own, the keypad next displays **MASTER? NO YES**. Select **YES** if you want this user to have a Master authority level.

Select **NO** if you want this user to have a Standard authority level. If you select **NO**, refer to item number 7 in the Adding User Codes section on the previous page.

Important: Changing a user code does not change the user number. User number two may have their user code changed from 1234 to 5678 but they are still user number two.

Schedules

User Code Level: Master only.

Function: The Schedules function allows you to program into the system the times at which you normally turn your burglary protection on and off each day of the week. This information can then be used by the system to automatically arm or disarm the burglary protection.

You can also use the Closing Check/Extend feature with Schedules to help ensure your system is armed by an authorized user at a specific time. This option sounds the keypad buzzer and displays **CLOSING TIME!** when a schedule expires. Users still on the premises are reminded to arm the system or extend the schedule to a later time. If the system is not armed, or the schedule not extended, a report can be sent to the central station and/or a pager.

Your system provides you with two different types of schedules:

Permanent schedules are used for automatic arming and disarming and always occur at the same time until you change or delete them.

Extend schedules allow an authorized user to extend the present day's permanent scheduled closing time.

Setting an Arming and Disarming Schedule

1. Access the User Menu.
2. Press the COMMAND key until **SCHEDULES?** displays. Press any SELECT key. The keypad displays **PRM EXT**. Press the SELECT key under **PRM**.
3. The keypad next displays the day of the week you want the schedule to start as **SUN MON TUE WED**. Press the COMMAND key to show the remaining days of the week and then press the SELECT key under your choice.

Schedules

User Code Level: Master only.

Function: The Schedules function allows you to program into the system the times at which you normally turn your burglary protection on and off each day of the week. This information can then be used by the system to automatically arm or disarm the burglary protection.

You can also use the Closing Check/Extend feature with Schedules to help ensure your system is armed by an authorized user at a specific time. This option sounds the keypad buzzer and displays **CLOSING TIME!** when a schedule expires. Users still on the premises are reminded to arm the system or extend the schedule to a later time. If the system is not armed, or the schedule not extended, a report can be sent to the central station and/or a pager.

Your system provides you with two different types of schedules:

Permanent schedules are used for automatic arming and disarming and always occur at the same time until you change or delete them.

Extend schedules allow an authorized user to extend a permanent scheduled closing time.

Setting an Arming and Disarming Schedule

1. Access the User Menu.
2. Press the COMMAND key until **SCHEDULES?** displays. Press any SELECT key. The keypad displays **PRM EXT**. Press the SELECT key under **PRM**.
3. The keypad next displays the day of the week you want the schedule to start as **SUN MON TUE WED**. Press the COMMAND key to show the remaining days of the week and then press the SELECT key under your choice.

4. The keypad then displays **OP** (open) **00:00 PM MON** followed by **CL** (close) **00:00 PM MON** and **DELETE KEEP**. Press the SELECT key under **DELETE**.

The keypad displays **OPENING TIME?**. Press COMMAND. The keypad now displays **MON - : AM PM**. Enter the time you want the burglary protection to be turned *off*. Use a 12 hour clock only (00:01 to 11:59). Press the SELECT key under AM or PM.

5. The keypad then displays **CLOSING TIME?**. Press the COMMAND key. The keypad then displays **MON - : AM PM**. If you want the schedule to be for consecutive days, press the SELECT key under **MON** to increment the days of the week. When the correct day is shown, enter the time you want the burglary protection to turn *on*.

Extended Schedules

Function: This option allows users to extend today's programmed closing time schedule.

Extending a Closing Schedule

1. Access the User Menu.
2. Press the COMMAND key until **SCHEDULES?** displays. Press any SELECT key.
3. The keypad displays **PRM EXT**. Press the SELECT key under **EXT**.

The keypad displays **- : AM PM**. Enter in the new time for the closing schedule to expire.

User Menu 19

4. The keypad then displays **OP** (open) **00:00 PM MON** followed by **CL** (close) **00:00 PM MON** and **DELETE KEEP**. Press the SELECT key under **DELETE**.

The keypad displays **OPENING TIME?**. Press COMMAND. The keypad now displays **MON - : AM PM**. Enter the time you want the burglary protection to be turned *off*. Use a 12 hour clock only (00:01 to 11:59). Press the SELECT key under AM or PM.

5. The keypad then displays **CLOSING TIME?**. Press the COMMAND key. The keypad then displays **MON - : AM PM**. If you want the schedule to be for consecutive days, press the SELECT key under **MON** to increment the days of the week. When the correct day is shown, enter the time you want the burglary protection to turn *on*.

Extended Schedules

Function: This option allows users to extend today's programmed closing time schedule.

Extending a Closing Schedule

1. Access the User Menu.
2. Press the COMMAND key until **SCHEDULES?** displays. Press any SELECT key.
3. The keypad displays **PRM EXT**. Press the SELECT key under **EXT**.

The keypad displays **- : AM PM**. Enter in the new time for the closing schedule to expire.

User Menu 19

Date and Time

User Code Level: Master only.

Function: Allows you to change the current date and time displayed on the keypad and used by the system for schedules and Display Events.

Setting the Date and Time

1. Access the User Menu.
2. Press COMMAND until **TIME?** displays.
3. The keypad displays the current day and time. Press the COMMAND key. The keypad displays the current date. Press the COMMAND key to make any changes.
4. The keypad displays **TIME DAY DATE**.
5. Press the SELECT key under **TIME** to change the time. The keypad displays – : **AM PM**. Enter the current time and select **AM** or **PM**.

The display changes back to **TIME DAY DATE**.

6. Press the SELECT key under **DAY** to change the day of the week. The keypad displays **SUN MONTUE WED**. If the current day is not displayed, press the COMMAND key. Press the SELECT key under the correct day.

The display changes back to **TIME DAY DATE**.

7. Press the SELECT key under **DATE** to change the date. The keypad displays:

MONTH: – Enter one or two digits for the month. Press COMMAND.

DAY: – Enter up to two digits for the day. Press COMMAND.

YEAR: – Enter up to two digits for the year. Press COMMAND.

The display returns to **TIME DAY DATE**. Press the ARROW key to exit the User Menu.

20 User Menu

Date and Time

User Code Level: Master only.

Function: Allows you to change the current date and time displayed on the keypad and used by the system for schedules and Display Events.

Setting the Date and Time

1. Access the User Menu.
2. Press COMMAND until **TIME?** displays.
3. The keypad displays the current day and time. Press the COMMAND key. The keypad displays the current date. Press the COMMAND key to make any changes.
4. The keypad displays **TIME DAY DATE**.
5. Press the SELECT key under **TIME** to change the time. The keypad displays – : **AM PM**. Enter the current time and select **AM** or **PM**.

The display changes back to **TIME DAY DATE**.

6. Press the SELECT key under **DAY** to change the day of the week. The keypad displays **SUN MONTUE WED**. If the current day is not displayed, press the COMMAND key. Press the SELECT key under the correct day.

The display changes back to **TIME DAY DATE**.

7. Press the SELECT key under **DATE** to change the date. The keypad displays:

MONTH: – Enter one or two digits for the month. Press COMMAND.

DAY: – Enter up to two digits for the day. Press COMMAND.

YEAR: – Enter up to two digits for the year. Press COMMAND.

The display returns to **TIME DAY DATE**. Press the ARROW key to exit the User Menu.

20 User Menu

Display Events

User Code Level: Master or Standard.

Function: Allows you to review up to 100 past events that occurred on your system from any keypad. Once 100 events are stored, any new event causes the oldest event to be cleared.

Note: This section shows the User's Guide Display Events items for both 16-character (single line) and 32-character keypad displays. While in the Display Events function, use the COMMAND and ARROW keys to go forward or backward through the list of events.

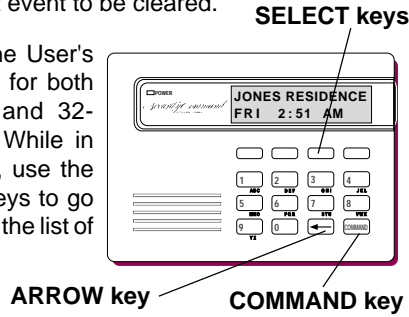

Using the Display Events Function

1. Access the User Menu.
 2. Press the COMMAND key until **DISPLAY EVENTS?** displays. Press any SELECT key.
 3. The keypad displays **FIRST LAST**. Select **FIRST** to view events starting from the oldest to the newest. Select **LAST** to view events starting from the newest to the oldest.
- If you select **FIRST**, use the COMMAND key to scroll up through the events displays.
- If you select **LAST**, use the ARROW key to scroll down through the event displays.

Display Events

User Code Level: Master or Standard.

Function: Allows you to review up to 100 past events that occurred on your system from any keypad. Once 100 events are stored, any new event causes the oldest event to be cleared.

Note: This section shows the User's Guide Display Events items for both 16-character (single line) and 32-character keypad displays. While in the Display Events function, use the COMMAND and ARROW keys to go forward or backward through the list of events.

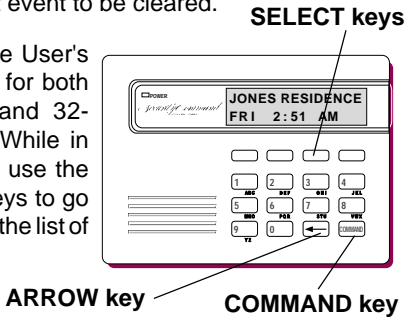

Using the Display Events Function

1. Access the User Menu.
 2. Press the COMMAND key until **DISPLAY EVENTS?** displays. Press any SELECT key.
 3. The keypad displays **FIRST LAST**. Select **FIRST** to view events starting from the oldest to the newest. Select **LAST** to view events starting from the newest to the oldest.
- If you select **FIRST**, use the COMMAND key to scroll up through the events displays.
- If you select **LAST**, use the ARROW key to scroll down through the event displays.

Zone Bypass Event Displays

This displays the bypassing of system zones.

16-Character Display **Description**
26 BYPS 12 1017 Zone 26 bypassed by user 12. Press the *left* Select key for the zone name and the *right* Select key for the time.

32-Character Display **Description**
BYP 5:18P 10/17 EAST WINDOW The east window zone was bypassed. Press a Select key for the zone number and user number.

Bypass Event Types - There are 4 event types:

- BYP** - Bypass **RST** - Restore **FRC** - Force Arm
- FLT** - Zone Fault

Note: You may sometimes see the **user** as SWG or SCH. These are short for Swinger Bypass and Schedule which are automatic functions that allow the system to bypass a zone.

Zone Bypass Event Displays

This displays the bypassing of system zones.

16-Character Display **Description**
26 BYPS 12 1017 Zone 26 bypassed by user 12. Press the *left* Select key for the zone name and the *right* Select key for the time.

32-Character Display **Description**
BYP 5:18P 10/17 EAST WINDOW The east window zone was bypassed. Press a Select key for the zone number and user number.

Bypass Event Types - There are 4 event types:

- BYP** - Bypass **RST** - Restore **FRC** - Force Arm
- FLT** - Zone Fault

Note: You may sometimes see the **user** as SWG or SCH. These are short for Swinger Bypass and Schedule which are automatic functions that allow the system to bypass a zone.

Zone Event Displays

This section displays alarms, troubles, and other events that could occur on your protection zones.

16-Character Display	Description
2 BURG ALR 1017	A burglary alarm occurred on zone 2. Press the <i>right</i> Select key for the time the alarm occurred.

32-Character Display	Description
ALR 10:23P 10/17 BASEMENT DOOR	An alarm occurred at 10:23 PM on Oct. 17. Press any Select key to see the zone number and zone type.

Zone Type - There are 7 possible zone types you may see here.

FIRE - Fire	PANC - Panic	BURG - Burglary
EMRG - Emergency	SUPV - Supervisory	
AUX1 - Auxiliary 1	AUX2 - Auxiliary 2	

Event Types - There are 6 event type you may see here:

ALR - Alarm	TBL - Trouble	RST - Restore
LOW - Low battery	MIS - Missing xmitter	

Note: LOW and MIS are for wireless systems only.

22 User Menu

Zone Event Displays

This section displays alarms, troubles, and other events that could occur on your protection zones.

16-Character Display	Description
2 BURG ALR 1017	A burglary alarm occurred on zone 2. Press the <i>right</i> Select key for the time the alarm occurred.

32-Character Display	Description
ALR 10:23P 10/17 BASEMENT DOOR	An alarm occurred at 10:23 PM on Oct. 17. Press any Select key to see the zone number and zone type.

Zone Type - There are 7 possible zone types you may see here.

FIRE - Fire	PANC - Panic	BURG - Burglary
EMRG - Emergency	SUPV - Supervisory	
AUX1 - Auxiliary 1	AUX2 - Auxiliary 2	

Event Types - There are 6 event type you may see here:

ALR - Alarm	TBL - Trouble	RST - Restore
LOW - Low battery	MIS - Missing xmitter	

Note: LOW and MIS are for wireless systems only.

22 User Menu

Arming and Disarming Event Displays

This displays any arming or disarming of system areas.

16-Character Display	Description
ARM 3 12 1017	Area 3 has been armed by user 12. Press the <i>left</i> Select key for the area name. Press the <i>right</i> Select key for the time the arming occurred.

32-Character Display	Description
ARM 5:10P 10/17 PERIMETER	The Perimeter was armed at 5:10 PM. Press any Select key to display the area number and user number.

Arming Event Types - There are 2 event type you may see here:

ARM - User armed the system	DIS - User disarmed the system
------------------------------------	---------------------------------------

User Checkin Event Displays

This shows when a user selected the pager **Checkin** feature from the User Menu. See page 13 for more information.

16-Character Display	Description
CHECKIN 16 1017	User 16 selected the Checkin feature on Oct. 17. Press the <i>right</i> Select key for the Checkin time.

32-Character Display	Description
MSG 3:31P 10/17 CHECKIN USER: 16	User 16 selected the Checkin feature at 3:31 PM on Oct.17.

Arming and Disarming Event Displays

This displays any arming or disarming of system areas.

16-Character Display	Description
ARM 3 12 1017	Area 3 has been armed by user 12. Press the <i>left</i> Select key for the area name. Press the <i>right</i> Select key for the time the arming occurred.

32-Character Display	Description
ARM 5:10P 10/17 PERIMETER	The Perimeter was armed at 5:10 PM. Press any Select key to display the area number and user number.

Arming Event Types - There are 2 event type you may see here:

ARM - User armed the system	DIS - User disarmed the system
------------------------------------	---------------------------------------

User Checkin Event Displays

This shows when a user selected the pager **Checkin** feature from the User Menu. See page 13 for more information.

16-Character Display	Description
CHECKIN 16 1017	User 16 selected the Checkin feature on Oct. 17. Press the <i>right</i> Select key for the Checkin time.

32-Character Display	Description
MSG 3:31P 10/17 CHECKIN USER: 16	User 16 selected the Checkin feature at 3:31 PM on Oct.17.

User Code Change Event Displays

This displays any addition, deletion, or change to a user code.

16-Character Display	Description
12 ADD 19 1017	User 12 added user 19 on Oct. 17. Press the <i>right</i> Select key for the time this occurred.

32-Character Display	Description
ADD 11:41A 10/17 US:19 BY US:12	User 19 added by user 12 at 11:41 AM.

User Code Event Types - There are 3 event type you may see here:
ADD - User added **DEL** - User deleted
CHG - User code or authority level has been changed.

Supervisory Event Displays

This displays the date and time of an automatic test report.

16-Character Display	Description
AUTO RECALL 1017	The test report was sent on Oct. 17.

32-Character Display	Description
MSG 11:58P 10/17 AUTO RECALL	The test report was sent to the central station at the date and time shown.

User Code Change Event Displays

This displays any addition, deletion, or change to a user code.

16-Character Display	Description
12 ADD 19 1017	User 12 added user 19 on Oct. 17. Press the <i>right</i> Select key for the time this occurred.

32-Character Display	Description
ADD 11:41A 10/17 US:19 BY US:12	User 19 added by user 12 at 11:41 AM.

User Code Event Types - There are 3 event type you may see here:
ADD - User added **DEL** - User deleted
CHG - User code or authority level has been changed.

Supervisory Event Displays

This displays the date and time of an automatic test report.

16-Character Display	Description
AUTO RECALL 1017	The test report was sent on Oct. 17.

32-Character Display	Description
MSG 11:58P 10/17 AUTO RECALL	The test report was sent to the central station at the date and time shown.

System Monitor Event Displays

This displays any loss of the system's AC power or battery.

16-Character Display	Description
POWER TBL 1017	An AC failure occurred on the system. Press the <i>right</i> Select key for the time.

32-Character Display	Description
TBL 1:05A 10/17 AC POWER	An AC failure occurred at 1:05 AM.

System Monitor Event Types - There are 2 event types:

TBL - Trouble **RST** - Restore

System Monitor Event Names - There are 2 system monitors:

AC POWER **BATTERY**

SERVICE REQUEST?

This feature of the User Menu allows you to just press any top row SELECT key while **SERVICE REQUEST?** is displayed and have the system automatically send a "Request for Service" message to the central station. The display changes to **REQUEST MADE** momentarily to confirm your request was sent.

Our service department will then contact you to arrange a service appointment.

Note: This feature is not displayed if it has not been enabled on your system.

User Menu 23

System Monitor Event Displays

This displays any loss of the system's AC power or battery.

16-Character Display	Description
POWER TBL 1017	An AC failure occurred on the system. Press the <i>right</i> Select key for the time.

32-Character Display	Description
TBL 1:05A 10/17 AC POWER	An AC failure occurred at 1:05 AM.

System Monitor Event Types - There are 2 event types:

TBL - Trouble **RST** - Restore

System Monitor Event Names - There are 2 system monitors:

AC POWER **BATTERY**

SERVICE REQUEST?

This feature of the User Menu allows you to just press any top row SELECT key while **SERVICE REQUEST?** is displayed and have the system automatically send a "Request for Service" message to the central station. The display changes to **REQUEST MADE** momentarily to confirm your request was sent.

Our service department will then contact you to arrange a service appointment.

Note: This feature is not displayed if it has not been enabled on your system.

User Menu 23

System Setup

We've provided this System Setup section to allow you to track the current status of the programmable options on your Security Command system. If you make changes to the system, you should update the information contained on these pages.

My system is monitored by a central station.

Yes No

C/S Name: _____

Address: _____

City/State: _____

Emergency Phone: _____

Service Phone: _____

Service Manager: _____

My system sends Opening and Closing reports.

Yes No

My system sends Zone Bypass reports.

Yes No

My system sends Ambush reports.

Yes No

System Setup

We've provided this System Setup section to allow you to track the current status of the programmable options on your Security Command system. If you make changes to the system, you should update the information contained on these pages.

My system is monitored by a central station.

Yes No

C/S Name: _____

Address: _____

City/State: _____

Emergency Phone: _____

Service Phone: _____

Service Manager: _____

My system sends Opening and Closing reports.

Yes No

My system sends Zone Bypass reports.

Yes No

My system sends Ambush reports.

Yes No

Protection Areas

Number	Description
1	_____
2	_____
3	_____
4	_____

Outputs

Your system has 4 outputs that can be used for various functions. Below is a list of these outputs and the devices they control.

Output #	What it controls
1	_____
2	_____
3	_____
4	_____

Enter the Output number above when using the Outputs On Off User Menu option to manually toggle the outputs.

User Codes

Your system provides 32 user codes you can program for individual users. As you add new users or change current users' codes, you can keep track of their name, user number, and other information here in this section. Use a pencil to allow for changes.

Protection Areas

Number	Description
1	_____
2	_____
3	_____
4	_____

Outputs

Your system has 4 outputs that can be used for various functions. Below is a list of these outputs and the devices they control.

Output #	What it controls
1	_____
2	_____
3	_____
4	_____

Enter the Output number above when using the Outputs On Off User Menu option to manually toggle the outputs.

User	User Name	Level	Temp Code	Areas	Arm Only
1		M S	Y N	1 2 3 4	Y N
2		M S	Y N	1 2 3 4	Y N
3		M S	Y N	1 2 3 4	Y N
4		M S	Y N	1 2 3 4	Y N
5		M S	Y N	1 2 3 4	Y N
6		M S	Y N	1 2 3 4	Y N
7		M S	Y N	1 2 3 4	Y N
8		M S	Y N	1 2 3 4	Y N
9		M S	Y N	1 2 3 4	Y N
10		M S	Y N	1 2 3 4	Y N
11		M S	Y N	1 2 3 4	Y N
12		M S	Y N	1 2 3 4	Y N
13		M S	Y N	1 2 3 4	Y N
14		M S	Y N	1 2 3 4	Y N
15		M S	Y N	1 2 3 4	Y N
16		M S	Y N	1 2 3 4	Y N

Circle Your Selections

HOW TO FILL IN THIS TABLE

User - The User Number of the person authorized to use the system.

Level - Master or Standard authority.

Temp Code - Is this code set to expire after seven days?

All Areas - Does this user have the authority to arm and disarm all areas in the system?

Arm Only - Is this user restricted to just arming?

Refer to the User Codes section of this User's Guide for additional information.

User Codes

Your system provides 32 user codes you can program for individual users. As you add new users or change current users' codes, you can keep track of their name, user number, and other information here in this section. Use a pencil to allow for changes.

User	User Name	Level	Temp Code	Areas	Arm Only
1		M S	Y N	1 2 3 4	Y N
2		M S	Y N	1 2 3 4	Y N
3		M S	Y N	1 2 3 4	Y N
4		M S	Y N	1 2 3 4	Y N
5		M S	Y N	1 2 3 4	Y N
6		M S	Y N	1 2 3 4	Y N
7		M S	Y N	1 2 3 4	Y N
8		M S	Y N	1 2 3 4	Y N
9		M S	Y N	1 2 3 4	Y N
10		M S	Y N	1 2 3 4	Y N
11		M S	Y N	1 2 3 4	Y N
12		M S	Y N	1 2 3 4	Y N
13		M S	Y N	1 2 3 4	Y N
14		M S	Y N	1 2 3 4	Y N
15		M S	Y N	1 2 3 4	Y N
16		M S	Y N	1 2 3 4	Y N

Circle Your Selections

HOW TO FILL IN THIS TABLE

User - The User Number of the person authorized to use the system.

Level - Master or Standard authority.

Temp Code - Is this code set to expire after seven days?

All Areas - Does this user have the authority to arm and disarm all areas in the system?

Arm Only - Is this user restricted to just arming?

Refer to the User Codes section of this User's Guide for additional information.

User Codes

User	User Name	Level	Temp Code	Areas	Arm Only
17		M S	Y N	1 2 3 4	Y N
18		M S	Y N	1 2 3 4	Y N
19		M S	Y N	1 2 3 4	Y N
20		M S	Y N	1 2 3 4	Y N
21		M S	Y N	1 2 3 4	Y N
22		M S	Y N	1 2 3 4	Y N
23		M S	Y N	1 2 3 4	Y N
24		M S	Y N	1 2 3 4	Y N
25		M S	Y N	1 2 3 4	Y N
26		M S	Y N	1 2 3 4	Y N
27		M S	Y N	1 2 3 4	Y N
28		M S	Y N	1 2 3 4	Y N
29		M S	Y N	1 2 3 4	Y N
30		M S	Y N	1 2 3 4	Y N
31		M S	Y N	1 2 3 4	Y N
32		M S	Y N	1 2 3 4	Y N

Circle Your Selections

HOW TO FILL IN THIS TABLE

User - The User Number of the person authorized to use the system.

Level - Master or Standard authority.

Temp Code - Is this code set to expire after seven days?

All Areas - Does this user have the authority to arm and disarm all areas in the system?

Arm Only - Is this user restricted to just arming?

Refer to the User Codes section of this User's Guide for additional information.

26 System Setup

User Codes

User	User Name	Level	Temp Code	Areas	Arm Only
17		M S	Y N	1 2 3 4	Y N
18		M S	Y N	1 2 3 4	Y N
19		M S	Y N	1 2 3 4	Y N
20		M S	Y N	1 2 3 4	Y N
21		M S	Y N	1 2 3 4	Y N
22		M S	Y N	1 2 3 4	Y N
23		M S	Y N	1 2 3 4	Y N
24		M S	Y N	1 2 3 4	Y N
25		M S	Y N	1 2 3 4	Y N
26		M S	Y N	1 2 3 4	Y N
27		M S	Y N	1 2 3 4	Y N
28		M S	Y N	1 2 3 4	Y N
29		M S	Y N	1 2 3 4	Y N
30		M S	Y N	1 2 3 4	Y N
31		M S	Y N	1 2 3 4	Y N
32		M S	Y N	1 2 3 4	Y N

Circle Your Selections

HOW TO FILL IN THIS TABLE

User - The User Number of the person authorized to use the system.

Level - Master or Standard authority.

Temp Code - Is this code set to expire after seven days?

All Areas - Does this user have the authority to arm and disarm all areas in the system?

Arm Only - Is this user restricted to just arming?

Refer to the User Codes section of this User's Guide for additional information.

Easy Entry™ User's Guide

This section of the user's guide provides information on using the Easy Entry™ access control capability of the security command system. If your system is not currently using any access control devices, disregard this section. Easy Entry™ is built into every Security Command system and can be accessed using Easy Entry™ keypads.

There are three different operating modes: Door Strike, Arming and Disarming, and Entry Delay. All of the examples below assume that your system requires a user code to arm and disarm the protection.

DOOR STRIKE

Area and All/Perimeter Door Strike - From the Status List, present your card to the reader. Once it is validated by the system, the Door Strike relay activates. See **Door Strike Relay Operation** above. Home/Away systems only activate the Door Strike relay when arming and disarming.

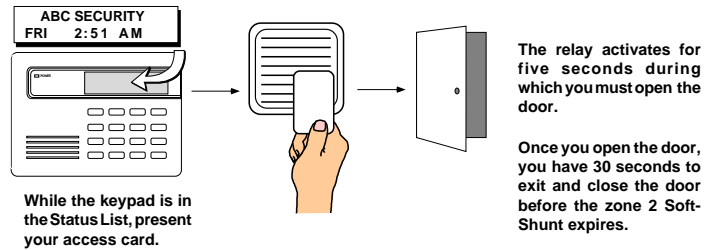

ARMING AND DISARMING AN AREA SYSTEM

Press Command. The keypad displays **ARM DISARM**. Press the Select key under either option. The keypad displays **ENTER CODE: -**. Present your card to the reader. Once it is validated by the system, all areas accessible by you arm or disarm automatically and the Door Strike relay activates.

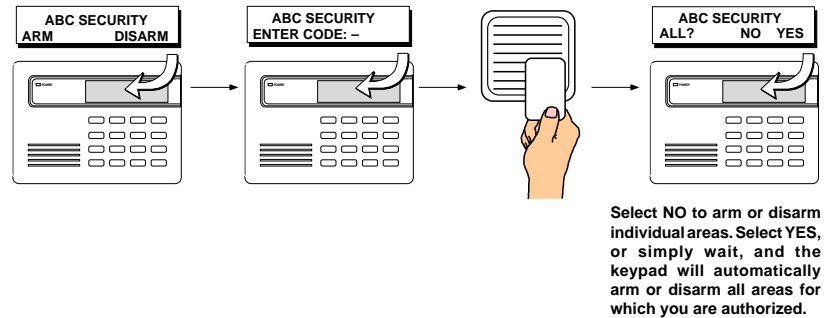

Easy Entry™ User's Guide

This section of the user's guide provides information on using the Easy Entry™ access control capability of the security command system. If your system is not currently using any access control devices, disregard this section. Easy Entry™ is built into every Security Command system and can be accessed using Easy Entry™ keypads.

There are three different operating modes: Door Strike, Arming and Disarming, and Entry Delay. All of the examples below assume that your system requires a user code to arm and disarm the protection.

DOOR STRIKE

Area and All/Perimeter Door Strike - From the Status List, present your card to the reader. Once it is validated by the system, the Door Strike relay activates. See **Door Strike Relay Operation** above. Home/Away systems only activate the Door Strike relay when arming and disarming.

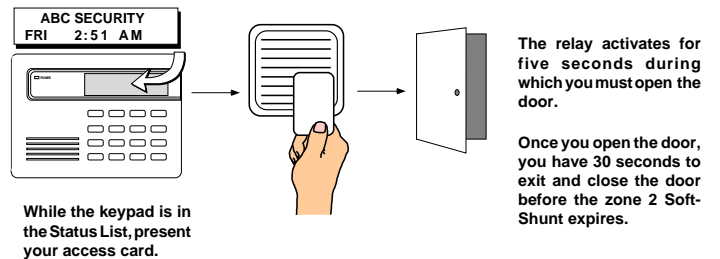

ARMING AND DISARMING AN AREA SYSTEM

Press Command. The keypad displays **ARM DISARM**. Press the Select key under either option. The keypad displays **ENTER CODE: -**. Present your card to the reader. Once it is validated by the system, all areas accessible by you arm or disarm automatically and the Door Strike relay activates.

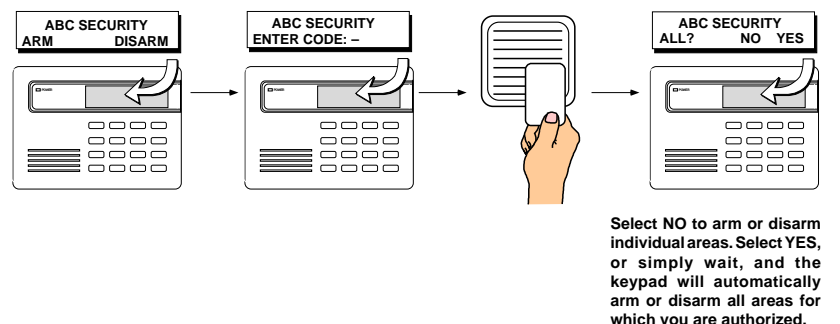

ARMING AND DISARMING AN ALL/PERIMETER SYSTEM

Press Command. The keypad displays **PERIM ALL** (when arming) or **DISARM?**. Press the Select key under the option. The keypad displays **ENTER CODE: -**.

Present your card to the reader. Once it is validated by the system, both areas arm or disarm automatically and the Door Strike relay activates.

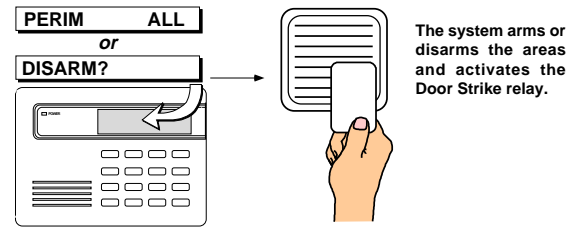

ARMING AND DISARMING A HOME/AWAY SYSTEM

Home/Away system Arming and Disarming - Present your card to the reader. If the system is armed, once the card is validated all areas are disarmed.

If the system is disarmed when you present your card, once it is validated all areas are armed in the **AWAY** mode.

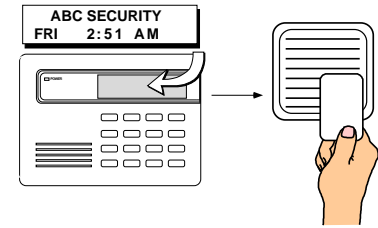

ENTRY DELAY

All Systems - Once the protected door is opened and the entry delay starts, the keypad displays **ENTER CODE: -**. Present your card to the reader and, once it is validated, the system disarms all areas accessible by you and activates the Door Strike relay. Area systems provide a delay to allow selected areas only to be disarmed. See Arming and Disarming above.

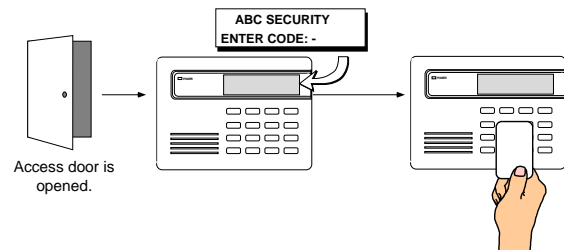

Using the access reader for user menu access

You can also use a card reader to access the User Menu when the **MENU? NO YES** display is shown.

The system disarms the areas and activates the Door Strike relay. Area systems allow a delay for you to select only certain areas. See Arming and Disarming.

ARMING AND DISARMING AN ALL/PERIMETER SYSTEM

Press Command. The keypad displays **PERIM ALL** (when arming) or **DISARM?**. Press the Select key under the option. The keypad displays **ENTER CODE: -**.

Present your card to the reader. Once it is validated by the system, both areas arm or disarm automatically and the Door Strike relay activates.

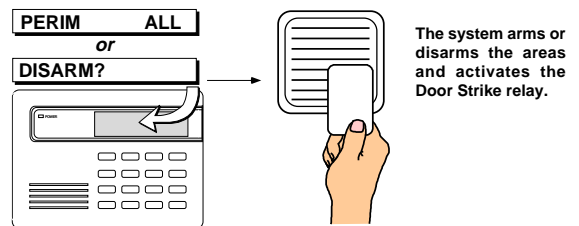

ARMING AND DISARMING A HOME/AWAY SYSTEM

Home/Away system Arming and Disarming - Present your card to the reader. If the system is armed, once the card is validated all areas are disarmed.

If the system is disarmed when you present your card, once it is validated all areas are armed in the **AWAY** mode.

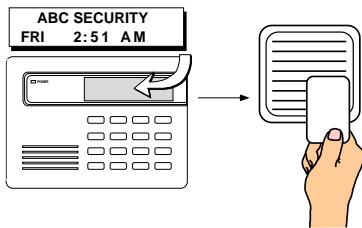

ENTRY DELAY

All Systems - Once the protected door is opened and the entry delay starts, the keypad displays **ENTER CODE: -**. Present your card to the reader and, once it is validated, the system disarms all areas accessible by you and activates the Door Strike relay. Area systems provide a delay to allow selected areas only to be disarmed. See Arming and Disarming above.

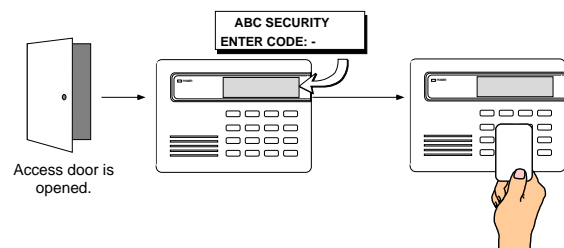

Using the access reader for user menu access

You can also use a card reader to access the User Menu when the **MENU? NO YES** display is shown.

The system disarms the areas and activates the Door Strike relay. Area systems allow a delay for you to select only certain areas. See Arming and Disarming.

Pager Direct™ User's Guide

Pager Direct uses the reporting capability of your security system to dial your pager number and send reports in much the same way as someone sending you a pager message would do. You can receive reports of alarms, troubles, or armings and disarmings of the system and know at a glance the status of your system.

Area Names			
List your system's area names and numbers below:			
Area	Name	Area	Name
1 _____		3 _____	
2 _____		4 _____	
Service Department Phone: _____			
Emergency Phone: _____			
Central Station Phone: _____			
Pager Direct™			
			
Security Command Alphanumeric Paging			

Cut along dotted lines

Area Names			
List your system's area names and numbers below:			
Area	Name	Area	Name
1 _____		3 _____	
2 _____		4 _____	
Service Department Phone: _____			
Emergency Phone: _____			
Central Station Phone: _____			
Pager Direct™			
			
Security Command Numeric Paging			

Cut along dotted lines

Fold

Pager Direct™ User's Guide

Pager Direct uses the reporting capability of your security system to dial your pager number and send reports in much the same way as someone sending you a pager message would do. You can receive reports of alarms, troubles, or armings and disarmings of the system and know at a glance the status of your system.

Area Names			
List your system's area names and numbers below:			
Area	Name	Area	Name
1 _____		3 _____	
2 _____		4 _____	
Service Department Phone: _____			
Emergency Phone: _____			
Central Station Phone: _____			
Pager Direct™			
			
Security Command Alphanumeric Paging			

Cut along dotted lines

Area Names			
List your system's area names and numbers below:			
Area	Name	Area	Name
1 _____		3 _____	
2 _____		4 _____	
Service Department Phone: _____			
Emergency Phone: _____			
Central Station Phone: _____			
Pager Direct™			
			
Security Command Numeric Paging			

Cut along dotted lines

Fold

Numeric Pager Display

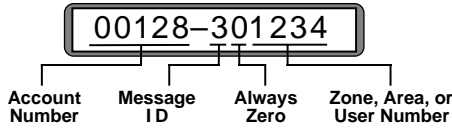

Account Number

This number has been programmed into your Security Command system as an identifier. Whenever the system sends a message to your pager, it will always send the account number first to identify itself.

Message ID

This is always a single digit, 1 to 6, that describes the message sent.

1 = Zone Alarm 3 = Area(s) Arming
2 = Zone Trouble 4 = Area(s) Disarming 6 = User Checkin

Zone, Area, or User Number

If this message is for a zone, the 1 to 2 digit zone number is displayed.

If this message is for areas that are being armed or disarmed, the area numbers are shown in sequential order. Example: 1 2 4.

Security Command Numeric Paging

Numeric Pager Display

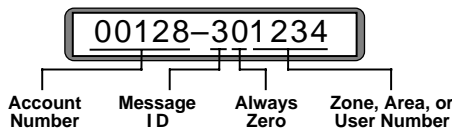

Account Number

This number has been programmed into your Security Command system as an identifier. Whenever the system sends a message to your pager, it will always send the account number first to identify itself.

Message ID

This is always a single digit, 1 to 6, that describes the message sent.

1 = Zone Alarm 3 = Area(s) Arming
2 = Zone Trouble 4 = Area(s) Disarming 6 = User Checkin

Zone, Area, or User Number

If this message is for a zone, the 1 to 2 digit zone number is displayed.

If this message is for areas that are being armed or disarmed, the area numbers are shown in sequential order. Example: 1 2 4.

Security Command Numeric Paging

Account Number

Whenever the system sends a message to your pager, it will always send the account number first to identify itself. After the account, you'll see:

Typical Zone Event Display Description

20002	001	NORTHWEST DOORS	BURG	*ALARM*	SHIPPING
Account	Zone	Zone Name	Zone Type	Event	Area Name

Zone Types - BURG, FIRE, SUPV (Supervisory), PANC (Panic), EMRG (Emergency), AUX1, or AUX2
Events - ALARM or TROUBLE

Typical Arming/Disarming Display Description

20002	ARMED	0016	01	EAST WAREHOUSE
Account	Event	User #	Area #	Area Name

Events - ARMED or DISARMED

User Checkin Display Description

20002	USER CHECKIN REPORT	BY 0016
Account	Function Performed	User #

Functions - USER CHECKIN REPORT (An authorized user has selected Checkin from the User Menu)

Typical System Event Display Description

20002	LATE TO CLOSE
Account	Event

Events - LATE TO CLOSE (The system has not been armed at its scheduled closing time)
ALARM CANCELLED (An alarm has been cancelled by an authorized user)

Security Command Alphanumeric Paging

Account Number

Whenever the system sends a message to your pager, it will always send the account number first to identify itself. After the account, you'll see:

Typical Zone Event Display Description

20002	001	NORTHWEST DOORS	BURG	*ALARM*	SHIPPING
Account	Zone	Zone Name	Zone Type	Event	Area Name

Zone Types - BURG, FIRE, SUPV (Supervisory), PANC (Panic), EMRG (Emergency), AUX1, or AUX2
Events - ALARM or TROUBLE

Typical Arming/Disarming Display Description

20002	ARMED	0016	01	EAST WAREHOUSE
Account	Event	User #	Area #	Area Name

Events - ARMED or DISARMED

User Checkin Display Description

20002	USER CHECKIN REPORT	BY 0016
Account	Function Performed	User #

Functions - USER CHECKIN REPORT (An authorized user has selected Checkin from the User Menu)

Typical System Event Display Description

20002	LATE TO CLOSE
Account	Event

Events - LATE TO CLOSE (The system has not been armed at its scheduled closing time)
ALARM CANCELLED (An alarm has been cancelled by an authorized user)

Security Command Alphanumeric Paging

PhoneAccess™ User's Guide

This exciting feature allows you to call your XR20 system from any outside touchtone phone to arm and disarm protection areas or turn on or off the panel's relay outputs.

How it works

1. From a touchtone phone, call the XR20 system's phone number.
2. The XR20 answers the call and sounds a short ready tone. You now have 8 seconds to enter a valid *Master* user code. If the user code is accepted by the panel, you'll hear one or more beeps giving you the current armed status of the system. (You can also find out the armed status of the system by pressing the * key at any time.)

If	You'll hear
All areas are armed	3 short beeps
Area 1 (Perimeter) is armed	1 short beep
Any area is armed	2 short beeps
All areas are disarmed	1 long beep

If the user code is *not* accepted by the panel, you'll hear four short beeps. Check the user code and try again. After 3 unsuccessful attempts to enter the code, the panel locks out PhoneAccess™ until a valid user code is entered at a keypad on the XR20 system.

3. Once the user code is accepted by the panel and the armed status is given, you can enter the following commands:

Press	To do this	You'll hear
#, 1	Arm all areas	3 short beeps
#, 2	Arm area 1	1 short beep
#, 3	Arm areas 1 & 2	2 short beeps
#, 0	Disarm all areas*	1 long beep
#, 5, 4, 0, n*	Toggles the output (* Use outputs 1, 2, 3, or 4 in place of n)	1 short beep = on 1 long beep = off 4 short beeps = restricted

Note: Zones in a bad condition are force armed when the area arms.

PhoneAccess™ User's Guide

This exciting feature allows you to call your XR20 system from any outside touchtone phone to arm and disarm protection areas or turn on or off the panel's relay outputs.

How it works

1. From a touchtone phone, call the XR20 system's phone number.
2. The XR20 answers the call and sounds a short ready tone. You now have 8 seconds to enter a valid *Master* user code. If the user code is accepted by the panel, you'll hear one or more beeps giving you the current armed status of the system. (You can also find out the armed status of the system by pressing the * key at any time.)

If	You'll hear
All areas are armed	3 short beeps
Area 1 (Perimeter) is armed	1 short beep
Any area is armed	2 short beeps
All areas are disarmed	1 long beep

If the user code is *not* accepted by the panel, you'll hear four short beeps. Check the user code and try again. After 3 unsuccessful attempts to enter the code, the panel locks out PhoneAccess™ until a valid user code is entered at a keypad on the XR20 system.

3. Once the user code is accepted by the panel and the armed status is given, you can enter the following commands:

Press	To do this	You'll hear
#, 1	Arm all areas	3 short beeps
#, 2	Arm area 1	1 short beep
#, 3	Arm areas 1 & 2	2 short beeps
#, 0	Disarm all areas*	1 long beep
#, 5, 4, 0, n*	Toggles the output (* Use outputs 1, 2, 3, or 4 in place of n)	1 short beep = on 1 long beep = off 4 short beeps = restricted

Note: Zones in a bad condition are force armed when the area arms.

Quick Reference Wallet Card

PhoneAccess™ Quick Commands

Press	To do this	You'll hear
# then 1	Arm all areas	3 short beeps
# then 2	Arm area 1	1 short beep
# then 3	Arm areas 1 & 2	2 short beeps
Note: Zones in a bad condition are force armed when the area arms.		
# then 0	Disarm all areas	1 long beep
#, 5, 4, 0, n*	Toggles the output (* Use outputs 1, 2, 3, or 4 in place of n) (Enter output descriptions below)	1 short beep = on 1 long beep = off 4 short beeps = restricted

1. _____ 3. _____

2. _____ 4. _____

PhoneAccess™ Quick Commands

Press	To do this	You'll hear
# then 1	Arm all areas	3 short beeps
# then 2	Arm area 1	1 short beep
# then 3	Arm areas 1 & 2	2 short beeps
Note: Zones in a bad condition are force armed when the area arms.		
# then 0	Disarm all areas	1 long beep
#, 5, 4, 0, n*	Toggles the output (* Use outputs 1, 2, 3, or 4 in place of n) (Enter output descriptions below)	1 short beep = on 1 long beep = off 4 short beeps = restricted

1. _____ 3. _____

2. _____ 4. _____

Cut along dotted lines

Appendix 31

Quick Reference Wallet Card

PhoneAccess™ Quick Commands

Press	To do this	You'll hear
# then 1	Arm all areas	3 short beeps
# then 2	Arm area 1	1 short beep
# then 3	Arm areas 1 & 2	2 short beeps
Note: Zones in a bad condition are force armed when the area arms.		
# then 0	Disarm all areas	1 long beep
#, 5, 4, 0, n*	Toggles the output (* Use outputs 1, 2, 3, or 4 in place of n) (Enter output descriptions below)	1 short beep = on 1 long beep = off 4 short beeps = restricted

1. _____ 3. _____

2. _____ 4. _____

PhoneAccess™ Quick Commands

Press	To do this	You'll hear
# then 1	Arm all areas	3 short beeps
# then 2	Arm area 1	1 short beep
# then 3	Arm areas 1 & 2	2 short beeps
Note: Zones in a bad condition are force armed when the area arms.		
# then 0	Disarm all areas	1 long beep
#, 5, 4, 0, n*	Toggles the output (* Use outputs 1, 2, 3, or 4 in place of n) (Enter output descriptions below)	1 short beep = on 1 long beep = off 4 short beeps = restricted

1. _____ 3. _____

2. _____ 4. _____

Cut along dotted lines

Appendix 31

1. Call the panel phone number. The panel answers and sounds one short tone.
2. Enter your code within 8 seconds. One beep means the code is good. Four short beeps means enter it again. You have 3 tries.
3. You have 30 seconds to enter the first command (see other side) and 30 seconds for each additional command.

If	You'll hear
All areas are armed	3 short beeps
Area 1 (Perim) is armed	1 short beep
Any area is armed	2 short beeps
All areas are disarmed	1 long beep

1. Call the panel phone number. The panel answers and sounds one short tone.
2. Enter your code within 8 seconds. One beep means the code is good. Four short beeps means enter it again. You have 3 tries.
3. You have 30 seconds to enter the first command (see other side) and 30 seconds for each additional command.

If	You'll hear
All areas are armed	3 short beeps
Area 1 (Perim) is armed	1 short beep
Any area is armed	2 short beeps
All areas are disarmed	1 long beep

32 Appendix

1. Call the panel phone number. The panel answers and sounds one short tone.
2. Enter your code within 8 seconds. One beep means the code is good. Four short beeps means enter it again. You have 3 tries.
3. You have 30 seconds to enter the first command (see other side) and 30 seconds for each additional command.

If	You'll hear
All areas are armed	3 short beeps
Area 1 (Perim) is armed	1 short beep
Any area is armed	2 short beeps
All areas are disarmed	1 long beep

1. Call the panel phone number. The panel answers and sounds one short tone.
2. Enter your code within 8 seconds. One beep means the code is good. Four short beeps means enter it again. You have 3 tries.
3. You have 30 seconds to enter the first command (see other side) and 30 seconds for each additional command.

If	You'll hear
All areas are armed	3 short beeps
Area 1 (Perim) is armed	1 short beep
Any area is armed	2 short beeps
All areas are disarmed	1 long beep

FA113 User's Guide

These instructions guide you through the operation of the XR20 Command Processor system using the FA113 Wireless Keychain Remote. The FA113 uses the audible output capability of the Security Command keypad to sound confirmation tones. It is recommended that you use the FA113 within hearing distance of these keypads.

Arming a Home/Away or All/Perimeter System

1. Press the **ON** button once to arm the Perimeter burglary protection. The Security Command keypads emit a single beep to confirm the arming. The Perimeter arms and all non-priority zones not in a normal condition are force armed.
2. After the single beep, press the **ON** button a second time to arm the Interior burglary protection. The Security Command keypads emit two beeps to confirm the arming.
3. After the two beeps, pressing the **ON** button in Home/Sleep/Away systems arms the Bedrooms burglary protection. The Security Command keypads emit three beeps to confirm the arming.

Disarming a Home/Away or All/Perimeter System

1. Press the **OFF** button once. The Security Command keypads emit a single 2-second beep to confirm the disarming.

Arming an Area System

1. Press the **ON** button once to arm the following areas:

1. _____ 2. _____ 3. _____ 4. _____

The Security Command keypads emit a single beep to confirm the arming.

Disarming an Area System

1. Press the **OFF** button once to disarm the above areas. The keypads emit a single beep to confirm the disarming.

Using the ALERT Buttons

Pressing the two **ALERT** buttons simultaneously sends a Panic alarm to the panel. If your system is monitored by a central station, the proper authorities will be notified of the alarm.

Appendix **33**

FA113 User's Guide

These instructions guide you through the operation of the XR20 Command Processor system using the FA113 Wireless Keychain Remote. The FA113 uses the audible output capability of the Security Command keypad to sound confirmation tones. It is recommended that you use the FA113 within hearing distance of these keypads.

Arming a Home/Away or All/Perimeter System

1. Press the **ON** button once to arm the Perimeter burglary protection. The Security Command keypads emit a single beep to confirm the arming. The Perimeter arms and all non-priority zones not in a normal condition are force armed.
2. After the single beep, press the **ON** button a second time to arm the Interior burglary protection. The Security Command keypads emit two beeps to confirm the arming.
3. After the two beeps, pressing the **ON** button in Home/Sleep/Away systems arms the Bedrooms burglary protection. The Security Command keypads emit three beeps to confirm the arming.

Disarming a Home/Away or All/Perimeter System

1. Press the **OFF** button once. The Security Command keypads emit a single 2-second beep to confirm the disarming.

Arming an Area System

1. Press the **ON** button once to arm the following areas:

1. _____ 2. _____ 3. _____ 4. _____

The Security Command keypads emit a single beep to confirm the arming.

Disarming an Area System

1. Press the **OFF** button once to disarm the above areas. The keypads emit a single beep to confirm the disarming.

Using the ALERT Buttons

Pressing the two **ALERT** buttons simultaneously sends a Panic alarm to the panel. If your system is monitored by a central station, the proper authorities will be notified of the alarm.

Appendix **33**

Index

- Alarm displays
 - how long in display 5
- Ambush codes 18
- Arming
 - All/Perimeter mode 9, 28
 - Area mode 7, 27
 - Home/Away mode 11, 28
 - Instant mode 9, 11
 - through the telephone 31
 - using Easy Entry™ 27
 - with doors and windows open 6
- BAD display 6
- Bypassing a zone 14
 - restoring a bypassed zone 14
 - zones that can't be bypassed 14
- Checkin reports to pager 13
- CLOSING TIME! display 19
- DIALING display 6
- Disarming, 1, 4
 - alarm display 8, 10,
 - clears alarm displays 5
 - during an alarm 10, 12
 - Easy Entry™ keypads 27
 - Easy Exit™ feature 12
 - ENTER CODE display 3, 8, 10 12
 - keypad display 8, 10
 - only selected areas 8
 - prewarn tone 8, 10, 12
 - reporting to central station 8, 10, 12
- LT-0303 (5/97)
- Door Strike operation 27
 - after Sensor Reset 13
- Easy Entry™ 13, 27
- Easy Exit™ feature 12
- Emergency procedures ii
- Entry and Exit zones 4
- Events held in memory
 - amount 21
- Exit Error 5
- Extending a schedule 19
- False Alarms 1
- Keypad messages 3
 - ALARM CANCELLED 10
 - ALREADY IN USE 18
 - BAD * 6
 - CLOSING TIME! 19
 - DIALING ... 6
 - INSTNT 11
 - LOCAL ALARM ONLY 6
- Keypad operation 2
- Keypad tones
 - during a trouble condition 3
 - entering while armed 3
 - Zone Monitor tone 3
- Keyswitch operation
 - exit delay display 6
 - user number zero 22
- Monitoring zones 15
- Outputs
 - names and numbers 14
 - turning on and off 14, 33
- Pager reporting 29
 - quick reference card 29
- Panic
 - alarms not displayed 5
- Perimeter protection 4
 - arming 9, 11
- Power (AC) LED 2
- Priority zone
 - BAD * condition 6
- Relay control 14
- Resetting a smoke detector 13
- Security Command keypad 1-2
- Sending reports to a Central station 5, 10
- Sending reports to your pager 29
- Sensor Reset 13
 - before using 13
 - for wireless systems 13
- Silent alarm 18
- System Setup 24
- System status 5
 - Panic zone alarms 5
- Testing the system 1, 15, 16
- Turning the system off, see Disarming
- Turning the system on, see Arming
- User Checkin 13
- User Codes 16
 - Ambush codes 18
 - area restrictions 17
 - arming only 17
 - authority level 16-17
 - deleting 18
 - Master codes 17
 - Temporary codes 17
 - user number 16
- User Menu 1
 - accessing 13, 28
 - restrictions 17
- Using Schedules 19
 - automatic arming 19
 - automatic disarming 19
- Using the keypad 2
 - arrow key 2
 - command key 2
 - top row keys 2
- Viewing past events 21
 - arming and disarming 22
 - system troubles 23
 - user code changes 23
 - zone alarms and troubles 22
- Wireless
 - Keychain Remote 33
 - low battery displays 13
- Zones 4
 - 24 hour zones 4
 - bypassing 6
- Zone Monitor 15
 - for testing the system 15

Index

- Alarm displays
 - how long in display 5
- Ambush codes 18
- Arming
 - All/Perimeter mode 9, 28
 - Area mode 7, 27
 - Home/Away mode 11, 28
 - Instant mode 9, 11
 - through the telephone 31
 - using Easy Entry™ 27
 - with doors and windows open 6
- BAD display 6
- Bypassing a zone 14
 - restoring a bypassed zone 14
 - zones that can't be bypassed 14
- Checkin reports to pager 13
- CLOSING TIME! display 19
- DIALING display 6
- Disarming, 1, 4
 - alarm display 8, 10,
 - clears alarm displays 5
 - during an alarm 10, 12
 - Easy Entry™ keypads 27
 - Easy Exit™ feature 12
 - ENTER CODE display 3, 8, 10 12
 - keypad display 8, 10
 - only selected areas 8
 - prewarn tone 8, 10, 12
 - reporting to central station 8, 10, 12
- LT-0303 (5/97)
- Door Strike operation 27
 - after Sensor Reset 13
- Easy Entry™ 13, 27
- Easy Exit™ feature 12
- Emergency procedures ii
- Entry and Exit zones 4
- Events held in memory
 - amount 21
- Exit Error 5
- Extending a schedule 19
- False Alarms 1
- Keypad messages 3
 - ALARM CANCELLED 10
 - ALREADY IN USE 18
 - BAD * 6
 - CLOSING TIME! 19
 - DIALING ... 6
 - INSTNT 11
 - LOCAL ALARM ONLY 6
- Keypad operation 2
- Keypad tones
 - during a trouble condition 3
 - entering while armed 3
 - Zone Monitor tone 3
- Keyswitch operation
 - exit delay display 6
 - user number zero 22
- Monitoring zones 15
- Outputs
 - names and numbers 14
 - turning on and off 14, 33
- Pager reporting 29
 - quick reference card 29
- Panic
 - alarms not displayed 5
- Perimeter protection 4
 - arming 9, 11
- Power (AC) LED 2
- Priority zone
 - BAD * condition 6
- Relay control 14
- Resetting a smoke detector 13
- Security Command keypad 1-2
- Sending reports to a Central station 5, 10
- Sending reports to your pager 29
- Sensor Reset 13
 - before using 13
 - for wireless systems 13
- Silent alarm 18
- System Setup 24
- System status 5
 - Panic zone alarms 5
- Testing the system 1, 15, 16
- Turning the system off, see Disarming
- Turning the system on, see Arming
- User Checkin 13
- User Codes 16
 - Ambush codes 18
 - area restrictions 17
 - arming only 17
 - authority level 16-17
 - deleting 18
 - Master codes 17
 - Temporary codes 17
 - user number 16
- User Menu 1
 - accessing 13, 28
 - restrictions 17
- Using Schedules 19
 - automatic arming 19
 - automatic disarming 19
- Using the keypad 2
 - arrow key 2
 - command key 2
 - top row keys 2
- Viewing past events 21
 - arming and disarming 22
 - system troubles 23
 - user code changes 23
 - zone alarms and troubles 22
- Wireless
 - Keychain Remote 33
 - low battery displays 13
- Zones 4
 - 24 hour zones 4
 - bypassing 6
- Zone Monitor 15
 - for testing the system 15